



IDAHO STATE HORSE SHOW ASSOCIATION
CONSTITUTION,
BY-LAWS
&
OFFICIAL RULE BOOK

2023 Edition

TABLE OF CONTENTS

Idaho State Horse Show Association History	1-1
Constitution	2-1
Name	2-1
Objectives	2-1
Membership	2-1
Officers and Directors.....	2-1
Meetings.....	2-2
Amendments to the Constitution	2-2
By-Laws	3-1
Dues	3-1
Officers	3-2
Delegates.....	3-3
Executive Committee.....	3-3
Elected Officers	3-4
Executive/Elected Officer Meetings.....	3-4
Ethical Practice Review Board and Licensed Officials Committee	3-4
Ethical Practice Review Board	3-5
Filing and content of protests.....	3-5
Licensed Officials Committee (LOC).....	3-7
Procedure for becoming an ISHSA judge.....	3-8
Appointment of Delegates	3-10
Meetings.....	3-10
Election of Officers.....	3-10
Vacancies	3-11
Liabilities	3-11
Annual Audit.....	3-11
Emergency Assessments.....	3-11
Compensation of Officers and Directors	3-12
Scholarship(s)	3-12
Amendments to By-Laws	3-12
Procedure for rules changes	3-12
Rules for Putting on a Show	4-1
General.....	4-1
Request for show approval.....	4-2
Local and non-point classes	4-2
Show Management Responsibilities.....	4-2
Conduct of Show Management, Exhibitors and Spectators.....	4-4
Miscellaneous Show Rules	4-4
Conduct.....	4-4
Judges.....	4-4

Ring Steward.....	4-5
Duties of an ISHSA Representative.....	4-5
Duties of an ISHSA Show Steward	4-6
Class Entry Fees.....	4-7
Breed Classes	4-7
Point Rating	4-8
Point Disputes	4-8
Insufficient Funds	4-8
Annual Point Awards.....	4-8
Protests.....	4-9
Classes to Be Shown and Judged as Designated	4-9
Addendum.....	4-9
Resources	4-10
General Showing Rules	5-1
Animal Welfare Policy	5-1
General.....	5-1
Audits.....	5-3
Gait Calls	6-1
Conformation Characteristics	7-1
ISHSA Approved Class List	8-1
Halter.....	8-1
Showmanship.....	8-1
English equitation	8-1
Western horsemanship.....	8-1
Reinsmanship (driving equitation).....	8-2
Lead-line, 6 and Under	8-2
English pleasure – hunt or saddle seat	8-2
Driving	8-2
Western pleasure.....	8-3
Trail.....	8-3
Western riding.....	8-4
Reining.....	8-4
Gymkhana.....	8-4
General notes for all classes.....	8-4
Rules for Halter Classes	9-1
General.....	9-1
Halter judging	9-1
Proper halter class to enter.....	9-4
Halter patterns.....	9-5
Championship halter	9-6
Class specifications and class default rule book.....	9-6

Rules for Showmanship Classes	10-1
General	10-1
Appearance	10-1
Grooming & fitting of animal	10-1
Presentation of animal.....	10-1
Class procedure	10-2
Western showmanship	10-2
English showmanship	10-2
Scoring rubric.....	10-3
Class specifications, default rule book, and score sheets.....	10-4
 Rules for Equitation Classes	 11-1
Equitation, horsemanship, reinsmanship, and lead-line.....	11-1
Hunter seat equitation	11-1
Saddle seat equitation	11-3
Western Horsemanship	11-4
Scoring rubric for English equitation & horsemanship	11-7
Reinsmanship equitation (driving equitation).....	11-8
Reinsmanship tests.....	11-9
Reinsmanship scoring rubric.....	11-19
Lead-line, 6 and under	11-20
Class specifications, default rule book, and score sheets.....	11-20
 Rules for English Pleasure Classes	 12-1
General	12-1
Hunter seat pleasure	12-1
Saddle seat English pleasure.....	12-3
Gaited horse English pleasure.....	12-4
English disciplined rail	12-8
Class specifications and default rule book.....	12-8
 Rules for Western Pleasure Classes	 13-1
General	13-1
Gaited horse western pleasure	13-6
Disciplined rail.....	13-10
Class specifications and default rule book.....	13-10
 Rules for Western Riding Classes	 14-1
General	14-1
Appointments.....	14-1
Patterns.....	14-2
Scoring Rubric	14-10
Class specifications, default rule book, and score sheets.....	14-12

Rules for Driving Classes	15-1
General regulations & appointments	15-1
Pleasure driving	15-1
Roadster driving.....	15-2
Disciplined rail driving	15-3
Class specifications and default rule book.....	15-3
 Rules for Trail Classes	 16-1
General.....	16-1
Mounted Trail	16-2
Appointments.....	16-2
General.....	16-2
In-hand trail.....	16-2
Appointments.....	16-2
General.....	16-2
Mandatory obstacles	16-3
Optional obstacles.....	16-6
Unacceptable obstacles	16-8
Scoring rubric.....	16-9
Class specifications, default rule book, and score sheets.....	16-11
Measurements	16-12
 Reining Classes.....	 17-1
General.....	17-1
Appointments.....	17-1
Patterns.....	17-1
Scoring rubric.....	17-15
Reiner rail.....	17-17
Class specifications, default rule book, and score sheets.....	17-18
 Rules for Gymkhana Classes	 18-1
General.....	18-1
Disqualification.....	18-1
Penalties	18-2
Appointments.....	18-2
Events	
Barrel racing.....	18-3
Flag race.....	18-4
Pole bending.....	18-5
Key race	18-6
Figure 8 stake race	18-7
Class specifications and default rule book.....	18-8

Rules for Ranch Classes	
General	19-1
Appointments	19-1
Ranch Horse Gaits	19-3
Class specifications, default rule book, and score sheets.....	19-3
Ranch Trail.....	19-4
Mandatory Obstacles	19-5
Optional Obstacles	19-5
Scoring Rubric	19-7
Ranch Riding	19-9
Scoring Rubric	19-10
Patterns.....	19-11
Ranch Reining.....	19-41
Scoring Rubric	19-41
Patterns.....	19-43
Ranch Rail Pleasure	19-50
Penalties	19-51
Ranch Conformation.....	19-52

THIS PAGE INTENTIONALLY LEFT BLANK

IDAHO STATE HORSE SHOW ASSOCIATION HISTORY

Rodna Smith had an idea, a new horse organization that would be economical and allow families to compete together. Based on Jackie Fuller's encouragement, Rodna reached out to various people in the horse community and presented her idea about the new horse organization. As a result, Idaho State Horse Show Association (ISHSA) was formed in the home of Ron & Rodna Smith, Sweet, ID January 1979. The new organization was based on the Indiana Saddle Horse Association that the Smiths were familiar with and the Kansas Open Horse Show Circuit that Jud & Virgil Morriss were familiar with. The new club was born. The first deposit for this organization was \$40.00, most of which was donated by the Smiths.

With the assistance of Fred and Anne Phillips, the first ISHSA show was held at the Gem County Fairgrounds in May of 1979. Hope and expectations were high. There were over 200 entries, and much excitement about this fledgling organization. There were 8 shows that first season, 3 sponsored by the new organization. The second year there were 12 shows, four of these sponsored by the parent club.

In 1980, Idaho State Horse Association, ISHSA, was incorporated in Gem County, State of Idaho, as a non-profit organization to promote the showing and care of all equine—horse, mule, donkey, and pony—breeds.

The first ISHSA banquet was held in November of 1981 at the Emmett High School gym. One hundred seventeen people attended. The year-end awards were gift cards from Lloyd's Country Store. Some awards were as much as \$500.00. All participants received award certificates for their placings in the shows held during the year.

ISHSA needed its own set of rules because the organization encompassed all breeds and disciplines so not one set of rules would be broad enough to serve the organization. Rodna set about writing the first ISHSA rule book with help from Jud and Virgil Morriss and Nola and Russ Krahn.

Due to the success of ISHSA in the Treasure Valley, a Magic Valley group headed by Phyllis Knapp ask for information. Ron and Rodna Smith and Anne and Fred Phillips met with the Magic Valley group. A new division of ISHSA was formed in the Magic Valley. Plans were discussed for a "Champion of Champion show" to be held in the fall after each area had completed their show season. This show would feature the top of each division. These Champion of Champion shows were held for several years but then were discontinued.

In 1989, ISHSA decided to formalize its judges and judging clinic. Bruce and Lana Jackson helped to organize the first ISHSA Judges Clinic. ISHSA decided to hire a professional judge to act as clinician. ISHSA modeled its judge's seminar and judges licensing process after the International Equine Judges Seminar, which is held annually in Oklahoma.

ISHSA has evolved adding classes and disciplines. The Smith's dream has become a reality. The ISHSA rule book has been written and rewritten several times as equine disciplines have changed and progressed. The ISHSA Judges Clinic has advanced to the point where it is now a nationally recognized judge's clinic for people seeking their national mule, donkey, or POAC judges card. ISHSA strives to keep current and yet stay true to its founding principles. This rule book presents the rules and by-laws of the Idaho State Horse Show Association (ISHSA). The Pinto Horse Association of America (PtHA) and American Quarter Horse Association (AQHA) provided a majority of the support material for this rule book; therefore, various sections of this rule book default to these organizations for situations not covered within this rule book.

This rule book supersedes any and all rules previously published by ISHSA.

Idaho State Horse Show Association Charter Members including their represented horse breed:

Ron and Rodna Smith--AQHA
Jud and Virgil Morriss--AQHA
Russ and Nola Krahn—Paint
Fred and Anne Phillips—AQHA and Paint
Bruce and Lana Jackson—Morgan
Jackie Fuller—Thoroughbred and AQHA

CONSTITUTION

ARTICLE I

Name

1. The name of this association shall be THE IDAHO STATE HORSE SHOW ASSOCIATION (ISHSA).

ARTICLE II

Objectives

1. Promote the education of the people of Idaho in the development of horses and horsemanship.
2. Encourage good sportsmanship and proper conduct among equestrians and to foster good fellowship among all persons interested in equines. For purposes of this organization the term horse or equine will be used as an all-inclusive term for all horse, mule, donkey, and pony breeds.
3. Encourage proper and humane handling and care of equine.
4. Prevent cruelty to all animals.
5. Establish and maintain an open, all breed equine show circuit.
6. This association shall be a non-profit organization with no capital stock.

ARTICLE III

Membership

1. Any person or persons who apply shall be entitled to a membership in this association upon payment of an annual membership fee as fixed by this association. Expiration of each annual membership shall be at the end of the fiscal year for which it was paid.
2. Four (4) categories of membership shall be available: individual, family, honorary, and member organization. An individual membership is a single membership. One member of the family may hold a family membership. A family includes parents, children, stepchildren, grandchildren, and/or wards. The executive committee at any general membership meeting may award an annual honorary membership. A member organization is an organization that chooses to send a delegate to the ISHSA meetings. Once the executive committee formally recognizes the delegate, he/she is entitled to one vote on the executive committee. This person must be an ISHSA member in good standing.

ARTICLE IV

Officers and Directors

1. The officers of the Idaho State Horse Show Association shall be president, immediate past-president, vice-president, secretary, treasurer, ethical practice review board and licensed officials committee (EPRB/LOC) chairman and three board of directors. Officers elected into an office in the year-end general election will be a paid member in good standing (for the year they will serve as an officer) by the end of the said meeting.

ARTICLE V

Meetings

1. There will be a monthly general membership meeting. The final meeting of the year is to be for the installation of officers. The time and place of the meetings shall be selected by the president and approved by the executive committee. Notice of these meetings shall be sent to all members no less than fifteen (15) days in advance. The president, acting president, or a majority of the executive committee may call an executive session.

ARTICLE VI

Amendments to the Constitution

1. The constitution of the association may be amended by a super-majority vote (66.7%) of the ISHSA members present at the year-end banquet, provided the proposed amendment has been read at one previous meeting or copies of the amendment sent to the members no less than fifteen (15) days in advance.

BY-LAWS

ARTICLE I

Dues

1. Any person or persons who apply shall be entitled to a membership in this association upon payment of an annual membership fee as fixed by this association. Expiration of each annual membership shall be at the end of the fiscal year for which it was paid.
2. Four (4) categories of membership shall be available: Individual, Family, Honorary, and Member Organization. An Individual Membership is a single membership. One member of the family may hold a Family Membership. A family includes parents, children, stepchildren, grandchildren, and/or wards. The Executive Committee at any General Membership Meeting may award an annual Honorary Membership. A Member Organization is an organization that chooses to send a delegate to the ISHSA meetings. Once the Executive Committee formally recognizes the delegate, he/she is entitled to one vote on the Executive Committee. This person must be an ISHSA member in good standing.
3. Each member whose dues are fully paid and who is in good standing shall be entitled to one vote at any regular General Membership or Special Meeting. A Family Membership shall be entitled to two votes at any regular General Membership or Special Meeting. Such votes shall be in person or by proxy unless balloting is done by mail or (postal or electronic). If balloting is by mail, a copy of the question, motion, or resolution shall be attached to the ballot.
4. Any group sponsoring a horse show may apply for ISHSA approval. Any group is entitled to schedule two (2) weekend shows with the approval of the Executive Committee. Show approval fees shall be determined at the Year-End General Membership meeting and shall be paid to the Secretary upon application for show approval. An individual sponsoring a horse show may apply for ISHSA approval; however, individuals will not be granted a delegate seat on the Executive Committee. Individuals putting on shows will be subject to all the same rules pertaining to putting on shows that Member Organizations must follow.
5. No final show approval will be granted unless show approval fees are paid in full and the sponsoring member is in good standing. Previous year show date(s) will be reserved until the end of February. If sanction fees are not received by that date, the reserved date(s) will become available. If two members request the same show date, determination of approval for that date will be given to the member that pays their sanction fee(s) to the Secretary first.
6. Membership applications and fees are to be sent to the Points Secretary. The Points Secretary is responsible to notify the Newsletter Editor and Secretary of the paid membership, and to provide the member with a current rule book. If a membership is paid at a show, the Show Secretary shall send the class sheets, the membership application, and funds to the Points Secretary. The Points Secretary is responsible for forwarding all funds to the Treasurer.

ARTICLE II

Officers

1. **PRESIDENT:** The President shall be the Executive Officer of the association; shall preside at all meetings of members and directors; shall have general and active management of the association; and shall see that all orders and resolutions of the Executive Committee are implemented. However, the Executive Committee has the right to delegate any specific power, except by statute exclusively conferred upon the President. The President shall execute or cause to be executed all contracts of the association; shall appoint any and all committees which in his/her discretion are necessary or proper; shall be a non-voting member of all committees; and shall have the general powers, supervision, and management usually vested in the office of the president.
2. **IMMEDIATE PAST PRESIDENT:** The Immediate Past President is an officer of the Executive Committee. The Immediate Past President serves until replaced. In order to serve as Immediate Past President, the out-going President must have completed his/her term of office as President.
3. **VICE-PRESIDENT:** In the absence or disability of the President, the Vice-President shall perform the functions of the office of the President. In addition, the Vice-President shall have the responsibility of organizing the annual Idaho State Horse Show Association show(s) and shall act as show manager.
4. **SECRETARY:** The Secretary shall attend all meetings of the Executive Committee and the General Membership. The Secretary will act as the clerk and will record all votes and minutes of the proceedings. Minutes shall be recorded and retained. The Secretary will perform like duties for the standing committees when required; shall notify all membership and the Executive Committee of all unscheduled meetings of the membership and the Executive Committee; and shall perform such other duties as specified by the Executive Committee or the President. The Secretary shall be a non-voting member of all committees.
5. **TREASURER:** The Treasurer shall keep full and accurate accounts of receipts and disbursements in books belonging to the association and shall deposit all money and other valuable effects in the name and to the credit of the association in such depositories as may be designated by the Executive Committee. The Treasurer shall disburse the funds of the association as ordered by the President or on the order of the Executive Committee taking proper vouchers for such disbursements. The Treasurer shall report to the President and officers at the regular meeting of the Executive Committee or whenever an account of transactions is required. In case of death, resignation, or removal from office; all books, papers, vouchers, money, and property of whatever kind in the Treasurer's possession belonging to the association shall be returned within thirty (30) days. At the end of the fiscal year, the Treasurer shall prepare, before turning over the books to the new Treasurer, or if retaining office within 30 days of the end of the fiscal year, a full and complete financial statement covering the fiscal year just completed to be presented at the first General Membership Meeting of the new year. The balance sheet and profit/loss statement will be published in the next following official newsletter. All financial records of the organization, paper or electronic, shall be maintained for a period of seven (7) years. No paper or electronic documents reaching the end of the retention schedule will be destroyed or deleted if pertinent to any ongoing or anticipated audit, investigation, or legal proceeding. After seven (7) years, retained financial records should be destroyed by a committee selected by the Executive Committee.

6. POINTS SECRETARY: The Points Secretary shall receive the completed show results from the individual ISHSA approved shows. The Points Secretary will publish point standings no later than six (6) weeks into show season. Successive point standings will be published in the newsletters throughout the show season. Final tabulations will be forwarded to the Secretary as soon as possible following the receipt of all show results. The Points Secretary, as a contracted person(s), shall receive compensation as per the negotiated Points Secretary contract.
7. EPRB/LOC CHAIRPERSON: The EPRB/LOC Chairperson shall be the chairperson of the EPRB/LOC; shall recommend to the Elected Officers all changes to the rule book, all changes to the approved class list, and all results of EPRB/LOC functions and hearings.
8. EXECUTIVE DIRECTORS: Three (3) shall be elected in the general membership election by the general membership and shall serve on the Executive Committee to represent the interests of the general membership.
9. ALL OFFICERS: All members of the Elected Officers Board must be members in good standing for the year from which they are elected and for the year in which they are to serve unless waived by a majority vote of members at a general meeting. Any individual may hold only one elected position per year and may not serve on more than two (2) committees of which he/she may not be the chairperson.
10. MISSING MEETINGS: Any ISHSA Director or Elected Officer that misses two (2) consecutive or four (4) meetings without calling or notifying the President may be replaced by a majority vote of the Executive Committee.
11. PROXY. If an officer, director, or delegate wishes to utilize a Proxy, notification of the Proxy must be made in writing, to the President and/or Secretary prior to the meeting where the Proxy will be utilized. The written notice shall include the scope and duration of the Proxy's authority. The Executive Committee or Elected Officers Board (depending on the meeting in question) shall recognize the Proxy prior to any business being discussed. Proxies must be members in good standing, and cannot serve as a Proxy if they already have a seat on the Committee or Board or have resigned from the Committee or Board within the calendar year. Officers, directors, delegates, committee members may participate in meetings via phone.

ARTICLE III

Delegates

1. Delegates shall consist of one (1) member from each member club or breed organization in good standing (1 delegate per organization). Each Delegate must also be a member in good standing (family or individual) and active in association activities. Delegates shall meet as part of the Executive Committee.

ARTICLE IV

Executive Committee

1. The Executive Committee of the Association shall consist of five (5) elected officials, (President, Vice-President, Secretary, Treasurer, and EPRB/LOC Chairperson), The Past President, three (3) Executive Directors, and one (1) Delegate per member organization. As a committee, all meetings are "open" to the General Membership or guests, unless specifically closed by a vote of the committee at the beginning of the meeting.

2. The Executive Committee shall manage and generally control the business, activities, and property of the association. The Executive Committee shall determine the approved horse show season. The Executive Committee shall have the power to originate changes as are deemed necessary throughout the year with respect to the official rule book. Any proposed change shall be voted on through mail ballot to the entire membership or by the majority in attendance at a duly called General Membership meeting.

Elected Officers Board

1. The Elected Officers Board shall consist of the 5 elected officials (President, Vice-President, Treasurer, Secretary, and EPRB/LOC Chairman) plus the 3 Directors and the Past President, for a total of 9 members. As a board, all meetings are “closed” to the General Membership unless specifically opened by a vote of the board at the beginning of the meeting.
2. The Elected Officers Board shall enforce compliance with ISHSA rules, as set forth in the official rule book, by ISHSA members, approved shows, and exhibitors. The Elected Officers Board, by a majority vote, shall rule on behalf of the association on EPRB/LOC recommendations.

Executive Committee/Elected Officers Board Meetings

1. A meeting of the Executive Committee may be called by the President or by request of the majority of members of the Committee. A meeting of the Elected Officers Board may be called by the President or by a majority of the members of the Board. Notice of a meeting of the Executive Committee or the Elected Officers Board must be provided at least seven (7) days prior to the meeting. Seven (7) day notification may be waived at the discretion of the President. Notification may be verbal or in writing.

ARTICLE V

Ethical Practice Review Board and Licensed Officials Committee

1. Due to the relatively small size of ISHSA, the Ethical Practice Review Board (EPRB) and the Licensed Officials Committee (LOC) will be one commission with dual duties. This commission formalizes the duties of those serving.

Ethical Practice Review Board & Licensed Officials Committee (EPRB/LOC)

1. The Ethical Practice Review Board and Licensed Officials Committee (EPRB/LOC) shall consist of six (6) members, all of whom are members of ISHSA for the duration of their terms of office. One member of the EPRB/LOC must hold a senior status judge’s card and one member must not be a judge.
2. The six (6) members of the EPRB/LOC shall be elected by the ISHSA membership in the annual general election to serve three-year rotating terms with two (2) terms expiring each year. A member of ISHSA’s Elected Officers shall make nominations for the EPRB/LOC.
3. Members of the EPRB/LOC are eligible for nomination and election to an unlimited number of terms.
4. Should a vacancy on the EPRB/LOC occur between general elections, the position may remain vacant until the next annual general election.
5. The EPRB/LOC consists of six (6) members, two (2) elected each year for a three (3) year term. The Chairman will be elected from the four (4) in place EPRB/LOC members by the general membership. The two (2) newly elected EPRB/LOC members are not eligible to be

Chairman even if they are currently serving on the EPRB/LOC and are reapplying for a position on the EPRB/LOC. After the election results are known or as soon thereafter as possible, the members of the EPRB/LOC shall elect one of their members to serve as Vice Chair. The Chair shall preside at all meetings of the EPRB/LOC. In the event the Chair is unable to chair a meeting or a hearing, the Vice Chair will preside. In the event the Chair or the Vice Chair is unable to chair a meeting or a hearing, those members present will select a Temporary Chair to preside at that meeting or hearing.

6. A quorum consisting of at least four (4) members of the EPRB/LOC shall be required to hear any matter.

Ethical Practice Review Board

Duties

1. The function of the EPRB shall be to interpret and enforce the ISHSA rules in cases brought before it for hearing. Its deliberations shall include, but are not limited to, consideration of whether an offense was intentional and whether it continued after either formal or informal warning.
2. In deciding upon a remedy for situations brought before the EPRB, it shall be the general policy of the EPRB to be constructive with those who have committed infractions, and to use its powers to prevent recurrence of the event. Probationary periods may be applied to effect discipline. Nothing in the foregoing, however, shall be construed to prohibit the strongest sanctions available against those persons found guilty of committing unethical acts or unsportsmanlike conduct.

Filing and content of protests

General

1. A protest and charge must state the full name and address of the accused and contain a complete and definite statement of the acts that constitute the alleged violation. Precise details regarding a violation of rules are necessary. The maker of the protest or charge is encouraged to list each rule alleged to have been violated. The maker of the protest or charge must be prepared to substantiate the protest or charge by personal testimony at a hearing or by sworn statements, witnesses or other evidence. The proponent of the protest has the burden of proof.
2. A rider, driver, handler, exhibitor, owner, agent, trainer, parent or guardian of a youth exhibitor, or show committee, may file a protest. Protests must be in writing.
3. The protestor must sign the protest.
4. Protests must be forwarded to the ISHSA secretary. If the protest involves a competition, the ISHSA secretary must receive the protest within six (6) days of the competition. Protests postmarked within six (6) days of the competition will be accepted as on time.
5. A \$25.00 filing fee must accompany protests. If any part of the protest is upheld, the \$25.00 fee will be returned to the person filing the protest. If the protest is found to be invalid, ISHSA will keep the \$25.00 fee.
6. The ISHSA secretary must immediately refer all protest to the EPRB.
7. The EPRB may investigate any protest, charge or alleged violation, may intervene in any protest and present evidence at a hearing concerning any protest, charge or alleged violation at its discretion. The EPRB may also attempt to arrange an agreement or dismissal of a

protest or charge in lieu of a hearing by reviewing all evidence and/or conducting interviews with the maker(s) and the respondent(s) to the protest or charge.

8. In the event the EPRB holds a hearing, the person(s) filing the protest and the accused must be present. In the event the accused is found guilty, he or she may be subject to any of the penalties listed under “*Violations and penalties*”. The EPRB chair will present the EPRB’s findings and the suggested penalty to the ISHSA’s Elected Officers Board. The final ruling in the matter shall be by majority vote of the ISHSA Elected Officers Board.
9. Notification of any penalty imposed will be published in the ISHSA newsletter.
10. Should a member of the EPRB/LOC be a protester or be the protested, he/she shall forgo the duties of an EPRB/LOC member and function solely as the protester or the protested.

Non-Protestable Decisions

1. The soundness of a horse, when determined by a veterinarian, is not protestable.
2. A judge’s decision, representing his/her individual preference, is not protestable unless it is alleged to be in violation of ISHSA rules.

Violations

A violation is any act prejudicial to the best interests of ISHSA, including but not limited to the following:

1. Violation of ISHSA rules.
2. Acting or inciting or permitting any other to act in a manner contrary to ISHSA rules, or in a manner deemed improper, unethical, dishonest, unsportsmanlike or intemperate, or prejudicial to the best interests of ISHSA.
3. Approaching a judge before or after a decision without first obtaining permission.
4. Inspecting a judge’s card without the judge’s permission.
5. Verbal abuse of a competition official.
6. Physical assault upon a person.
 - a. Cruelty to an equine. This includes but is not limited to the following: Excessive use of a whip. Intentional inhumane treatment that results in bleeding.
 - b. Withholding feed and water for prolonged periods.
 - c. Letting blood from a horse for other than diagnostic purposes.
 - d. Inhumane treatment.
 - e. Any action against a horse by an exhibitor deemed excessive by the judge. Such actions include but are not limited to excessive use of the whip, crop, or spurs.
7. Failure to obey any penalty imposed by ISHSA.
8. Failure to pay indebtedness to ISHSA.

Penalties

If found guilty, the accused will be subject to such penalty as the EPRB may determine, including but not limited to:

1. **CENSURE.** A vote of censure will be listed under the defendant’s name in the ISHSA’s secretary’s “record of penalties.” If found guilty of a further violation, the defendant will be subject to a heavier penalty than for the first offense.
2. **SUSPENSION** of such person for any period from showing or having others show, exhibit or train for him or her. A suspended person is forbidden for the time specified in the decision to

hold or exercise office in the ISHSA or in any recognized competition, from the privilege of taking any part whatsoever in any recognized competition and is excluded from all competition grounds during recognized competitions, as an exhibitor, participant, or spectator.

3. EXPULSION from recognized competitions.
4. EXPULSION or SUSPENSION from ISHSA membership.
5. FORFEITURE of trophies, ribbons, or prizes won in connection with the offense committed. Trophies, ribbons, or prizes will be redistributed.
6. SUSPENSION from office as representative, judge, or competition official.
7. REVOCATION of a judge's license.
8. FINE.
9. ISHSA affiliated organizations must honor all ISHSA penalties.

Licensed Officials Committee (LOC)

Duties

1. The LOC will act upon every completed application for enrollment, renewal, promotion and classification of judges. The LOC does not have the power to decline enrollment to any judge; an application may be declined only by a majority vote of the Elected Officers Board.
2. The LOC will issue a judge's card to each approved applicant. Cards are valid for three years.
3. The LOC is responsible for putting on the annual judges clinic.

Requirements for approval and classification of ISHSA recognized judges

1. The ISHSA recognized judges list will be maintained and published in accordance with the standards and procedures listed below. A revised list of recognized judges will be published annually. The recognized list will be disseminated to the affiliated clubs, shows of record, and to the ISHSA members. Changes of address, deletions and additions to the recognized list will be published from time to time in the ISHSA newsletter at the discretion of the LOC.

Procedure for becoming an ISHSA judge

1. Be a current ISHSA member in good standing.
2. Be at least twenty-one (21) years old.
3. Attend the annual ISHSA judge's seminar, receive a passing score of 70% or greater on the written test, and have the live judging scored. ISHSA prefers that prospective judges have some experience prior to attending the seminar; however, this is not required.
4. Successfully complete a judging apprenticeship as outlined in "*Five levels of judges*" below.
5. An individual's conduct as a member, exhibitor and judge, as well as his or her judging ability must be exemplary, and is subject to continual LOC review. Designation as an ISHSA Approved Judge is a privilege, not a right, and such designation is revocable by the LOC with or without notice and formal hearing, subject only to the ultimate review by the Elected Officers Board. Any member or individual approved or applying for approval as an ISHSA judge agrees to abide by the decision of the Elected Officers as a final determination of all rights to ISHSA judge status.

Six levels of judges

1. **Learner Judge:** A Learner Judge is a person with limited judging experience who has attended at least one (1) ISHSA judge's seminar. Learner judges are not allowed to judge ISHSA shows. Learner Judges must successfully serve an apprenticeship at four (4) ISHSA shows with four (4) different Senior Judges. The Senior Judge must complete an evaluation form and return it to the LOC within ten (10) days. When the LOC has received (4) passing evaluation forms for the Learner Judge, the Learner Judge becomes eligible to become a Junior Judge. Upon the LOC's determination that the candidate has received passing evaluations from the Senior Judges, has attended the required judges clinic, has submitted four (4) letters of character reference, and has passed the necessary tests at the judge's clinic; the Learner Judge's application to become a Junior Judge shall be passed on to the Executive Committee for an acceptance vote. Once a person has received Junior Judge status, the person is then allowed to judge ISHSA shows.
2. **Junior Judge:** A Junior Judge is a person who has successfully completed his/her learner judging experience and who has been granted Junior Judge status by the Executive Committee. Junior Judges may not have Learner Judges work under them and may not judge the double point shows.
3. **Senior Judge:** A Junior Judge may apply for Senior Judge status after having completed a minimum of two (2) years judging experience, judged a minimum of ten (10) shows (six (6) must be full day ISHSA approved shows (not partial shows) and four (4) may be other LOC preapproved full day open style shows), and received generally positive evaluations on the exhibitor and show management evaluation forms. Upon the LOC's receiving all of the necessary application materials and determines that the candidate has met the requirements for Senior Judge status, the Junior Judge's application for Senior Judge status shall be passed on to the Executive Committee for an acceptance vote. Senior Judges may train Learner Judges and may judge the double point shows.
4. **Nationally Carded Judges.** A not specialized Nationally Carded Judge may apply to the LOC to be considered for Senior Judge status. Upon the LOC's positive review, the applying individual's name will be passed along to the Executive Committee for final Senior Judge status approval. Nationally Carded Judges may judge any ISHSA approved show with the approval of the Executive Committee. It would be highly suggested that Nationally Carded Judges hired to judge ISHSA shows be well versed in multiple breeds and understand that ISHSA is an open all breed association. Nationally carded judges who hold specialty cards may only judge classes in that specialty area with the approval of the Executive Committee.
5. **Highly Qualified Judges.** A Highly Qualified Judge is a person who may not qualify as an ISHSA approved judge under the above categories, but is qualified to judge. For example, the person may be from another area and has a lot of judging experience and meets the open show judging standards for that area. Such a person would need to apply to the LOC for a one time per year variance to be allowed to judge one ISHSA show per year. Upon the LOC's favorable review of the person's qualifications, the Highly Qualified Judge's name would be passed on to the Executive Committee for an acceptance vote. Upon receiving an acceptance vote, the Highly Qualified Judge would be allowed to judge one ISHSA show per year. An approved Highly Qualified Judge may apply to the LOC to become a junior judge after successfully completing judging two (2) ISHSA shows and attending the ISHSA judges clinic. The LOC will review the application and pass their recommendation on to the Executive Committee for the final approval.

6. Specialty Category Judges. A person who desires to only judge specialty classes and has met the ISHSA's requirements for becoming a judge in that specialty area may be placed on the ISHSA judges list denoting the specialty area the person may judge. Such a judge will not be allowed to judge outside of their qualified specialty area. Examples may include but are not limited to trail, reining, and ranch.

Show management, exhibitors, and judges rights and responsibilities

1. Show management, exhibitors, and judges have the duty and the responsibility to take the opportunity to evaluate the show and the judge(s). Evaluation forms should be available at each show that allow for this opportunity. These forms should be able to be submitted confidentially to show management and then confidentially forwarded to the LOC chair. Forms may be submitted confidentially, but must be signed and dated to be official. Data collected from these forms will be used to evaluate shows and judges. Generalized data may be submitted to the Executive Committee or the Elected Officers Board on an as needed basis.

Requirements to retain an ISHSA judge's card

1. Junior Judges and Senior Judges are required to attend the annual ISHSA judges seminar once every three (3) years. The judges seminar consists of classroom instruction and live horse judging. Each year, all judges must complete an open book test and receive a passing grade, 70% or greater. In addition, judges attending the seminar must place all of the classes offered in the live judging and have their scores evaluated. The LOC scores the tests and the results of the tests are returned to the judges. Judges must also maintain current ISHSA membership.

Removal of judges from the ISHSA recognized judges list

1. A judge who does not meet one or more of the above requirements will be so notified in writing by the LOC. The LOC shall remove that individual's name from the recognized list until the deficiency has been corrected to the satisfaction of the LOC.
2. In the event of removal of a judge's name from the recognized list, for whatever reason, the judge will be permitted to fulfill only those written, contracted judging commitments, provided copies of such contracts are submitted immediately to the LOC. No additional judging assignments may be accepted until such time as the judge's name has been reinstated to the recognized list by the LOC.
3. A judge who has been found guilty of any misconduct by the EPRB and who has been suspended or placed on probation shall be removed and/or suspended from the recognized judges list for a specific period of time or be placed on probation by the LOC under the terms and conditions imposed by the EPRB hearing and ratified by the Elected Officers Board.
4. The LOC may recommend removal of a judge to the Elected Officers Board. The Elected Officers Board may accept or reject such recommendations.
5. A judge who has been declared not in good standing by the Elected Officers Board shall be automatically removed from the recognized list by the LOC until such time as the judge has been returned to good standing.
6. Any judge who is removed from the list, for whatever reason, and is not reinstated to the list for a period of one year (365 days) from removal, shall be deemed to be permanently

removed and will not have his/her name added to the recognized list until all requirements of "Procedure for becoming an ISHSA judge" have been met.

Reinstatement

1. A judge must apply in writing to the LOC for reinstatement to the recognized list upon updating or satisfying the requirements or removal of any deficiencies that caused the removal or rejection from the list.
2. The LOC may make allowances for extenuating circumstances when reinstating a judge.

ARTICLE VI

Appointment of Delegates

1. One (1) Delegate shall be appointed by each Member Organization involved with the Idaho State Horse Show Association. The Delegate's name must be reported to the Secretary at the beginning of each fiscal year. All Delegates must be members in good standing with the Idaho State Horse Show Association.

ARTICLE VII

Meetings

1. General membership and election meetings: *see Constitution, Article V.*
2. Special meetings: *see Constitution, Article V.*
3. Monthly meetings: The Executive Committee should hold a meeting once a month during the approved show season. The President shall assure that each applicable individual is advised of the time and place at least seven (7) days in advance.
4. Quorum: A majority of those present at any duly called meeting shall constitute a quorum.

ARTICLE VIII

Election of Officers

1. Officers of the association shall be elected by a mailed written ballot sent out to the entire membership prior to the December membership meeting. The written ballots shall be counted and the results announced at the December membership meeting. The term of office shall be for one year and shall start on the first day of the fiscal year or as otherwise determined by the Executive Committee.
2. Ballot protocol
 1. Completed ballots shall be mailed or hand delivered to an assigned uninterested party: defined as someone who is not on the ballot and who is not on the Elected Officers Board, or their immediately family members.
 2. The ballots may not change hands after they have been mailed to the assigned uninterested party until they are delivered to the year-end meeting unopened.
 3. The ballots will be opened & counted by three assigned people who are not on the ballot and who are not on the Elected Officers Board, nor their immediately family members.

ARTICLE IX

Vacancies

1. If the office of any Director or officer of the association becomes vacant by reason of death, resignation, disqualification, or otherwise, the Executive Committee shall select and install a new Director or officer to complete the term. Member organizations are required to notify ISHSA in writing in the event they must replace their Delegate.
2. Any Director or other officer may resign his/her office at any time; such resignation to be made in writing and to take effect from the time of its receipt by the Secretary, unless some other time is stated in the resignation. The acceptance of a resignation shall not be required to make it effective.

ARTICLE X

Liabilities

1. The association shall conduct its financial affairs on a fiscal year basis. The fiscal year is to be determined by the Executive Committee.
2. The association shall not have the power to subject itself to indebtedness exceeding the current funds in the treasury. Members of the association shall not be liable for any debts of the association.

Annual Audit

1. Each year prior to the end of the fiscal year, a committee of three (3) people appointed by the Executive Committee shall conduct an in-house audit and shall report their findings to the Executive Committee.

Emergency Assessments

1. When funds from dues are insufficient to meet the needs of the Idaho State Horse Show Association, the Executive Committee may levy an assessment sufficient to cover the necessary emergency expenditures, not to exceed \$10.00 per year per membership.
2. Members not paying the emergency assessment within thirty (30) days of being notified shall be considered delinquent and automatically suspended from membership in the ISHSA and therefore lose all points and year-end awards.

ARTICLE XI

Compensation of Officers and Directors

1. Officers and Directors shall not receive a salary for their services to the association but may be reimbursed for actual necessary expenses incurred. Request for reimbursement, along with receipts, shall be submitted to the Treasurer. All expenditures shall require approval of the Executive Committee before reimbursement. An Officer or Director may provide contracted services to ISHSA with the approval of the Executive Committee.

ARTICLE XII

Scholarship(s)

1. ISHSA may (as funds permit) choose to offer one or more educational scholarships. Due to continually changing laws and student needs, a Scholarship Committee shall determine the criteria for the execution of the Scholarship Fund. The Scholarship Fund shall be kept in a dedicated fund separate from the ISHSA general fund. The actions of the Scholarship

Committee and the criteria for the scholarship shall receive final approval from the Executive Committee.

2. As one method of generating funds for the educational scholarship(s), the Scholarship Committee may sell dedicated horse show numbers. Dedicated show numbers will be sold on an annual basis with first right of refusal to repurchase a specific dedicated number going to the previous year's purchaser of a given dedicated show number. Use of a dedicated number is a show participant's privilege and not a right; however, once that privilege has been purchased by an exhibitor, the use of that dedicated number may only be used by said purchaser for the year it was purchased for. Show management should not issue the sold numbers to any exhibitor except the purchaser. It will be the responsibility of the Scholarship Committee to produce and maintain a list of sold numbers. This list is to be kept readily available to ISHSA club members and show managements via the ISHSA newsletter, ISHSA website, the how to put on a show packet, email, and other appropriate methods of distributing this information.

ARTICLE XII

Amendments to By-Laws

1. The By-Laws of the association may be amended by a super-majority vote (66.7%) of the ISHSA members voting in a mailed written ballot, provided the proposed amendment(s) has been read at one previous meeting or copies of the amendment sent to the members no less than fifteen (15) days in advance of the vote.

PROCEDURE FOR RULE CHANGES

1. Rule proposals may be submitted year-round, but must be submitted no later than August 1 to be considered for the year-end ballot.
2. Rule proposals are to be submitted to the LOC-EPRB chairman (rules chairman) in writing. Rule proposals must include supporting materials. Rule proposals involving a class change or a new class must be accompanied by national standards (national rule book) that support the proposal.
3. The EPRB will review, research, revise, ask questions of the submitter, possibly invite the submitter to an EPRB meeting to further explain the proposal, etc. If the rule proposal has merit and is in-line with ISHSA open show format, standards, and current rule book, the measure will be presented to the executive committee by the LOC-EPRB chairman.
4. The executive committee shall review the rule proposal, possibly ask for revisions by the EPRB, and then pass it along to the entire membership for a final written approval vote.
5. The entire membership will have an opportunity to vote on the rule proposals via a written ballot.
6. Once approved by the ISHSA membership, the rule proposal will be added to the rule book.

RULES FOR PUTTING ON A SHOW

General

1. An approved show and its exhibitors shall be bound and governed by the current official ISHSA rule book. Any situation not specifically governed by the ISHSA rule book will be deferred to the current Pinto Horse Association of America (PtHA) rule book unless otherwise stated.
2. The Idaho State Horse Show Association rules shall apply to each and every approved show. One show shall not have special privileges over another show.
3. The approved show season of the ISHSA will commence with the first ISHSA two-judge show after April 1 and will culminate with the two-judge show prior to October 31 unless the Executive Committee grants a variance.
4. The ISHSA Executive Committee will be responsible to determine the season's show schedule. Organizations desiring to schedule an approved show must apply for a show date in writing. Application must be made to the ISHSA secretary and shall include at least three (3) preferred show dates in order of preference for each desired show. The Executive Committee will announce the approved show schedule to all the membership, but it shall remain tentative until all show's approval fees are paid. Open dates, if any, within the approved show season may be used as rain dates.
5. The ISHSA two-judge show, commonly referred to as the "Double Point" show, counts as two (2) shows for the exhibitors, but counts as one (1) show for the judge.
6. Each member organization is allowed two (2) approved weekend show dates per year. *See addendum for mid-week shows.* Only one (1) approved show may be scheduled on any one-calendar day unless it is a two-judge show, which counts as two (2) shows. Clubs that have sanctioned show dates from the previous year shall have first right of refusal until February 28 of the current show year. If the request for a show date is not received in writing by March 1 of the current year it becomes an available show date open to other organizations. Exceptions for mid-week shows are to be addressed and approved by the Executive Committee. Any other exceptions must be addressed and approved by the Executive Committee after March 1.
7. As of March 1, if two (2) associations have requested the same available show date, the determination of which association receives the sanction will be based on the first association to remit club and sanction fee(s) paid in full to the ISHSA secretary.
8. Association's sanctions will be revoked if the Treasurer has not received the \$1.00 per ISHSA class entry fee and the points secretary does not receive the show's results within fourteen (14) days after their show. In addition, future shows scheduled by the delinquent association will not be granted a sanction.
9. When there is only one entrant in a class, points will be awarded to the entry if the entry executes all maneuvers and/or gaits required in said class.
10. No ISHSA show will be held in any grass arena, roped off arena, picket fence, or any other non-permanent arena. The following are exceptions: halter and trail may be held outside the arena with the consent of a majority of the class exhibitors.
11. If any ISHSA show is canceled during the show, points will be allowed for those classes already conducted and the show may be rescheduled on a rain date. No new classes for points may be added to the original show program. Any classes already conducted with points awarded cannot be repeated.
12. ISHSA will assess a fee for returned checks.

13. ISHSA will not be responsible for dishonored checks written to member clubs for sanctioned shows; however, all points accumulated by the membership that wrote the dishonored check will be held from that point on until said check has been made payable.
14. The person who creates/selects the patterns for a show is not allowed to compete in those pattern classes at that show. In addition, the person who contacts, contracts, and signs the checks for the judge(s) for a show is not allowed to compete at that show.

Request for Show Approval

1. Affiliated organizations and/or any ISHSA approved show must be in good standing and must comply with ISHSA rules. The show bill must be in the hands of the ISHSA secretary, or other person designated to receive show bills, sixty (60) days prior to the show and be approved by the EPRB. The show bill must be received in this time period to ensure the show bill be listed in the ISHSA newsletter or official publication at least one time prior to the show. Every effort will be made to have correct wording, description of classes; classes listed in the order in which they will be conducted; entry fees; name of judge; name, address, and telephone number of the show secretary; date of the show; and time the show is to start. If the show bill is NOT in the ISHSA's possession sixty (60) days in advance of the show, a \$50 fine may be levied against the affiliated organization. Once a show bill is published, unless an emergency situation occurs, it cannot be changed unless a 30 day or more notice to exhibitors can be provided.

Local and Non-Point Classes

1. To be approved for points, a show must offer a minimum of 60 classes from the ISHSA approved class list or 90% of the show's classes must be from the ISHSA approved class list. Shows may offer non-ISHSA classes. These classes will not receive ISHSA points. ISHSA classes and non-ISHSA classes must be clearly designated as such on the show bill.

Show Management Responsibilities

1. The judge hired must be from the ISHSA approved judges list, approved by the executive committee, or hold a national judging card. The hiring of the judge is the responsibility of the member organization.
2. The show management is responsible for mailing each of the judges on the ISHSA's approved judges list a copy of the current ISHSA rule book. It is the judge's responsibility to bring the rule book to events where he/she is officiating. If show management hires a nationally carded judge that is not on the ISHSA's approved judges list, it is show management's responsibility to mail the judge a copy of the current ISHSA rule book. This must be done at least two (2) weeks prior to the show at which he/she will be officiating.
3. Upon the judge's arrival, it is the responsibility of the show manager to brief the judge on special classes or any changes in the show.

4. It shall be recommended to the member show to present a trophy or award for 1st place and ribbons for 2nd through 6th places, and it is suggested that participation ribbons be given to all exhibitors in classes for ages eleven (11) and under.
5. All show secretaries are required to keep records and judge's cards of their show for one (1) full year from the show date so records can be checked if necessary.
6. Classes must be held in the same order as previously advertised and listed on the show bill. If a class has less than four (4) entries it may be combined with another class at the discretion of the show management as long as the exhibitors don't object and there is no specific prohibition of combining the classes. The combined classes will be judged simultaneously, but placed separately. Points will be awarded according to placing as if the classes were run separately.
7. At the judge's and show management's discretion, youth classes may be split if there are more than fifteen (15) exhibitors and adult classes may be split with twenty (20) or more exhibitors. At least the top four (4) in each split or at least eight (8) competitors will return for a final go round to attain class points. In split classes, the judge will conduct each section as if it were an individual class.
8. Show secretaries are responsible to collect a fee of \$1.00 per ISHSA class entry. The fee will be collected at the approved show, turned over to the ISHSA treasurer within fourteen (14) days, and placed in a dedicated fund for year-end awards. Organization show sanctions will be revoked if the ISHSA treasurer does not receive the \$1.00 (per ISHSA class entry, per judge) fee within this time frame.
9. Show management is responsible to see that any patterns used at their show are posted a minimum of one hour prior to the class where the pattern will be used. Some show managements may choose in addition to posting the patterns at the show to also post the patterns online via various outlets. If show management chooses to do this, the patterns are required to first be posted on the official ISHSA website as this is the official source of information for all participants. After the patterns have been published on the official ISHSA website, then they may be posted by the show management in any manner they choose. Once patterns have been published, unless deemed unsafe or illegal, the show must use the published patterns.
10. The management of the ISHSA sponsored beginning and ending of the show season shows, popularly called the "Double Point" shows, are responsible to see that all classes listed on the approved class list for that given year are offered at the shows.
11. It is suggested that the show manager inspect the arena for good working order before the show starts. If the show is canceled, there will be no refund of the show approval fee and the canceling show assumes the responsibility for notifying exhibitors of cancellation. If canceled due to weather or other acts of God, approval fee can be transferred to the rain date.
12. Each organization shall be required to furnish the ISHSA points secretary with a record showing the placing of each class through 7th place, the total number of entries per class, and the name of the owner and the exhibitor. These records are to be assembled in the same manner as the show was held. If a class was canceled or combined, this should be duly noted and must be signed by the show secretary and/or horse show manager. It shall be forwarded and post marked within fourteen (14) days after the closing date of said show. Any organization or show that does not submit the show results within the required fourteen (14) day time limit shall be fined

\$50.00 and will not be allowed any future show dates until all fines are paid and show results are received.

13. Organizations putting on a show shall send a complete show bill to all paid ISHSA members if said show bill is not published in ISHSA newsletter or official publication.

Conduct of Show Management, Exhibitors, and Spectators

1. Every person who takes part in a show is responsible to know the ISHSA rule book and is subject to the ISHSA rules.

Miscellaneous Show Rules

The following paragraphs are intended to cover miscellaneous incidents arising at a show.

Conduct

1. When an exhibitor and/or representative acting on behalf of the exhibitor is guilty of showing poor sportsmanship, the association can suspend the rights of such exhibitor and/or representative from participating in future approved shows for such a period as judged appropriate; and the association can bar from participation in any association approved event, all animals registered in such suspended person's name according to association records during the term of his/her suspension.
2. All exhibitors, riders, owners, trainers, parents, grooms or anyone guilty of misconduct or inhumane treatment of an animal on or about the show grounds will upon receipt of a formal written complaint from either the judge, show committee, or association representative be subject to suspension for such a period as judged appropriate depending on the seriousness of the offense. In addition, point accumulation will be suspended. The elected officers will make the final decision in such cases. This act of suspension will be published in the membership newsletter.

Judges

1. It is suggested that a judge will appear no less than thirty (30) minutes before the start of show.
2. Neither the judge, members of his/her family, or students shall exhibit, act as agents or representative in any capacity, or handler of a horse in any approved class at a show or contest at which he/she is officiating. A horse may not be shown under a judge if that judge has been owner, trainer, agent in any capacity, or conditioner of that horse within the previous sixty (60) days. If such a horse is entered in a show, its entry fee shall be refunded and it is not to be exhibited. A judge may be suspended from the list of approved judges for infraction of this rule at the ruling of the elected officers. Exception: Audits.
3. Once a class has been judged, it shall not be re-judged; and once the judge has marked his/her final record, there shall be no changing of places. If clerical corrections are made, the judge must initial them. If the number of exhibitors in a class warrants, the class should be placed through 7th.
4. No judge shall determine eligibility for registration of any entry in the ring.
5. A judge may order any person or horse from the arena for bad conduct.

6. A learner judge may work with a senior judge upon receiving the judge and show management's permission.
7. A judge, upon arrival in a city in which he/she is to officiate, is to contact an official of the show or contest and advise that official of his/her presence and location.
8. When requested by an exhibitor, through the show management or ring steward, the judge is urged to give his/her opinion courteously and sincerely. In no way should a class or show be held up due to lost time with exhibitors holding question and answer sessions with a judge.
9. The judge may not ask any exhibitors to switch horses.
10. A judge may only officiate at three (3) member shows per show season. Variances may be granted by a vote of the executive committee.
11. The judge may not also be the show manager or the show secretary.
12. It is suggested that the judge(s) post his/her score sheet following the completion of the pattern class for which the score sheet pertains.
13. Due to the large number of classes available, some member organizations use a split judge format, hiring a second judge for specific classes in a second arena (no classes are offered twice). Additionally, on occasion a show meets the minimum standards to hold an ISHSA sanctioned show, however the ISHSA classes are minimal. Therefore, any judge who judges less than 30 individual ISHSA sanctioned classes at a show shall be credited with judging only half a show.

Ring Steward

1. Qualifications

- A. The ring steward shall be familiar with approved ISHSA show procedures.
- B. The ring steward may not hold the position of show manager or show secretary.

2. Conduct

- A. The ring steward is selected to help the judge, NOT ADVISE, argue, or criticize.

3. Duties in the ring

- A. The ring steward assembles classes promptly in order to keep judging on schedule and eliminate delays between classes.
- B. The ring steward helps the judge by relieving him/her of unnecessary details.
- C. The ring steward notifies the judge when all horses are present for each class. **NO HORSE WILL BE ADMITTED TO THE CLASS ONCE THE STEWARD NOTIFIES THE JUDGE THAT THE GATE IS CLOSED.**
- D. The ring steward:
 1. Should act as mediator between judge, exhibitors, gate person, and announcer.
 2. Moves and places horses as the judge requests.
 3. Has the authority to ask an exhibitor to remove his/her horse for the safety of other horses and spectators at the judge's request.
 4. Should try to limit the possibilities of an accident.
 5. Shall not advise or comment to the judge on the activities of the class. He/she will maintain a minimum distance from the judge unless otherwise requested.

Duties of an ISHSA Representative

1. The Representative of ISHSA should point out in a diplomatic manner any instance where ISHSA rules are not enforced and should immediately report to the appropriate officials any violations of the rules which might invalidate a class; should remain available to judges, exhibitors, and management at all times to clarify the application of ISHSA rules and investigate any situation where the rules are not upheld. The ISHSA representative should clearly understand that he/she has no authority in connection with the management or the judging of a show.
2. The ISHSA Executive Committee shall appoint a qualified member of the Executive Committee, EPRB/LOC members, Elected Officers Board, ISHSA judge, or any other appropriately qualified persons approved by the Executive Committee to serve as ISHSA representative; one (1) of which to be present at each approved member show.
3. The member show is responsible for announcing the representative's name prior to and during said show.
4. The representative is required to check in with the show management upon arrival at said show grounds.
5. The ISHSA representative has the authority to have a disruptive exhibitor removed from the show.

Duties of an ISHSA Show Steward

The position of ISHSA Show Steward is specifically for the ISHSA Double Point shows (other shows may utilize a Show Steward if they desire) versus a Show Representative.

1. Stewarding Privileges: Designation as an ISHSA Show Steward is a privilege, not a right, bestowed by the Executive Committee according to procedures formulated by ISHSA. The privilege shall be open to individuals whose experience and expertise, as well as personal character, merits the honor. An individual's conduct as a member, exhibitor, and steward and his/her ability must be exemplary. An individual's conduct will be subjected to continuous review.
 - A. Stewards must attend the annual ISHSA judge's clinic at least once every three (3) years
 - B. Maintain current ISHSA membership or executive committee approval
 - C. Pass an open book, written rule book exam with at least a 90%.
2. Approval and Testing:
 - A. Applicant must be at least twenty-five (25) years of age and must have been an ISHSA member in good standing for at least one calendar year immediately preceding application before he/she can be considered for approval.
 - B. New applicants must submit five (5) letters of recommendation with a resume to ISHSA's LOC at least thirty (30) days prior to the annual judge's clinic.
 - C. Prospective stewards must attend the ISHSA's annual judge's clinic; pass an open book, written rule book exam with at least a 90%; complete two (2) learner stewarding apprenticeships; and have their names submitted to the executive committee for final approval.

3. Guidelines:
 - A. Stewards should remain available to judges, exhibitors, and show management at all times to clarify the application of ISHSA rules and investigate any situation where the rules are not upheld.
 - B. Stewards are to be available to consult with show management and judges concerning ISHSA rules, but do not have the authority to override decisions made by show management or judges.
 - C. Stewards do have the authority to point out in a diplomatic manner any violations of the rules: examples include but are not limited to situations which might invalidate a class, animals are being treated inhumanely, unsportsmanlike conduct, etc. In such a case where a class may be invalidated or a potential for a protest exists, the steward may immediately assemble the available EPRB/LOC members who will render an undisputable decision without the necessity of a formal protest. The steward and the EPRB/LOC will assist show management in executing the rendered decisions.
4. Duties of the show steward include but are not limited to:
 - A. Protect the interests of the exhibitors, judges and show management.
 - B. The show steward must represent all contestants with the show management and judge(s) and will be the sole liaison with said management or judge(s).
 - C. To immediately investigate and act upon any alleged rule violations.
 - D. To verify that ISHSA rules are followed.
 - E. To report to the show management and ISHSA any offense or violation.
 - F. To make routine inspections of the arena and stable areas and to ensure that these areas are maintained in a safe manner for the horses, exhibitors, and spectators; report areas of deficiency to show management.
 - G. Monitor show grounds for inhumane treatment of animals and unsportsmanlike conduct.
 - H. Answer exhibitor's questions about rules.
 - I. Investigate complaints.

Class Entry Fees

1. There will be a ceiling on the entry fees for any ISHSA approved class. This ceiling on entry fees will be set annually, before the first show of the season, by the executive committee. There will be an ISHSA year-end awards fee of \$1.00 per ISHSA class entry (per judge at the Double Point show) charged at all ISHSA sanctioned shows. This fee is to be included in the entry fee and therefore the entry fee per class may not exceed the ceiling amount set by the executive committee. No office charges or grounds fees may be charged for ISHSA approved classes.

Breed Classes

1. Horses shown in breed classes have to be registered accordingly (i.e. a Quarter Horse can only be shown in the Quarter Horse class if it is papered with AQHA, otherwise it needs to be shown as a grade horse). Copies of registration papers must be available upon request to the Point Secretary to be eligible to show in breed classes.

Point Rating

First Place	6 points
Second Place	5 points
Third Place	4 points
Fourth Place	3 points
Fifth Place	2 points
Sixth Place	1 point

Plus one (1) point for each horse you placed over in the class.

Point Disputes

1. Any question or dispute in connection with the competition for these awards shall be referred for decision to the executive committee of the ISHSA. Its verdict shall be final. The ISHSA points secretary will keep a final record of any member show for sixty (60) days after the awards banquet.

Insufficient Funds

1. Upon receiving notification from any member organization about an individual's insufficient funds check, ISHSA will hold all accumulated points for that membership until the executive committee receives notification that said situation has been resolved. Points will then be reactivated.

Annual Point Awards

1. The Points Secretary of the ISHSA will keep accumulation of points for annual awards for ISHSA MEMBERS ONLY. Showmanship, equitation, horsemanship, and reinsmanship driving points will be recorded on the exhibitor when he/she is a member and a member owns the animal used. In all other point classes, the points will be kept on the animal but only if and when the animal is owned AND exhibited by an individual or family member in good standing. The owner of the horse is defined as the person(s) whose name is on the breed registration papers, legal brand certificate, and/or a Bill of Sale. Also to be considered as owner is the person with a contract showing he/she is the person buying or leasing the horse.
2. Leased equine: If the owner of a leased animal is not a current ISHSA member, the lease holder (exhibitor) must provide written documentation signed by the equine's owner and lease holder detailing the lease agreement to the points secretary before the equine is shown for points to count. The exhibitor (lease holder) must be a member of ISHSA to show the equine since the lease holder will in all essence be considered to be the equine owner; however, the actual owner does not have to be a member for points to count.
3. Trainers collecting fees for outside horses are not considered owners.
4. Awards will be presented to the riders or owners of those horses earning the highest ratings in each division listed in the current rules and who have placed in five (5) or more of the ISHSA sanctioned shows (in the same class) held during the calendar year. Ranking for division high point awards will be computed in accordance with the following general regulations:
 - a. Properly marked results from the member show shall be the sole basis upon which rating will be computed, and the score thus derived shall be the final

authority in determining the awards in each division. The Idaho State Horse Show Association points secretary will use every care to achieve accuracy in computing the ratings, but neither the points secretary nor the association will be liable for the failure of any member show to file the results of their show, nor for errors or omissions in the marking thereof, nor responsible beyond the point of accuracy in computing the final ratings from the results submitted by the proper authorities of each show. Only those points earned at member shows conducted under the standard rules of the association will be included in the ratings. No points will be credited for ribbons won at non-member shows even though such show is conducted in accordance with association rules.

- b. The cumulative score earned by any entry within the respective classification shall be included in the final rating, regardless of transfer of ownership within the period of competition. The owner of the animal at the time of scoring its last point shall be the recipient of the award.
- c. Points are not retroactive -- they accumulate only from the date of membership.
- d. In order for an approved class to be eligible for year-end awards, the class must have been offered a minimum of five (5) times during the point season.

Protests

1. Disputes are not to be taken to the judge during a show by an exhibitor. They are to be taken to the ISHSA Representative. The ISHSA Representative will present the concern to the judge at an appropriate time. (*See duties of the ISHSA representative*)
2. Any exhibitor lodging protest after a class has been judged must be an ISHSA member in good standing.
3. Requirements:
 - A. Must deposit \$25.00 with the Secretary of ISHSA.
 - B. All protests must be in writing, signed by the protester.
 - C. Must be received by the Secretary within six (6) days after the show.
 - D. The person making the protest must carry the burden of proof, not the EPRB
4. Results:
 - A. The Secretary must immediately refer all protests to the EPRB.
 - B. The EPRB will review the protest and make a recommendation to the elected officers.
 - C. The elected officers will make the final ruling.

Classes to Be Shown and Judged as Designated

1. Problems involving policy and questions arising at the shows, not specifically covered by the rules below, will be directed to the EPRB/LOC and after review will be directed to the Elected Officers.

Addendum

1. If a person or organization wants to put on midweek shows, these shows are defined as midweek, evening shows that do not include halter classes. Proper show attire under the ISHSA rule book is waived for these shows only, however, no tube tops or shorts are allowed. Boots or shoes with a heel and proper tack (as defined by ISHSA rules) are required.
2. For the midweek shows, judges are credited with judging half a show. Exhibitors are granted ISHSA full points.

Resources

The PtHA rule book can be found at <https://pinto.org>

The AQHA rule book can be found at <https://www.aqha.com>

GENERAL SHOWING RULES

ANIMAL WELFARE POLICY

1. No person on show grounds, including, but not limited to, barns, stalls, parking area, and the show arena, may treat an equine in an inhumane manner. The standard by which conduct or inhumane treatment will be measured is that which a reasonable person, informed and experienced in generally accepted equine training and exhibition procedures, would determine to be cruel, abusive, and inhumane.
2. Horses showing signs of undue stress or inhumane treatment must be penalized. The exhibition of a horse that has a cut or abrasion showing clear evidence of fresh blood in the mouth, nose, chin, shoulder, barrel, flank or hip area must be considered to be ineligible to receive an award in that respective class.
3. Upon discovery by a show official of inhumane treatment, show management shall immediately take action on the matter by reporting it to the EPRB.
4. If abuse to an animal has resulted in owner/rider/representative of the animal to be removed from show grounds via judge/steward/management, ISHSA may revoke points/prizes earned at that show by animal upon review of a filed protest.

Default rule books: For situations that are not covered by the ISHSA rule book, ISHSA will default to the AQHA and the PtHA rule books for guidance in the resolution of situations involving inhumane treatment. To stay compliant with changes in the equine industry, ISHSA will following the lead of such changes made by AQHA and PtHA. ISHSA will follow suit without needing to specifically vote on the changes.

GENERAL

1. Refer to the regulations for each division.
2. The term “horse” is used as a generality in reference to all equines.
3. Supplemental hair in mane and tail is permitted in any division. (Unless class rules specify otherwise.) Artificial tails consisting of fabric/leather and hair are permissible. Tails may be lengthened by hair to hair attachment only with no attachments of any kind to the tailbone. Weighted tails are permissible as long as they are humane. The designated judge or equipment judge shall determine if the tail meets these standards. The decision of the judge will be final.
4. Earplugs or cotton in the horse’s ears is allowed.
5. Placing of a horse’s feet by hand is permitted unless class rules specify otherwise.
6. Any tack and/or attire infraction is to be considered as a penalty, not a disqualification, unless specific class rules require a disqualification.
7. Western and English styles of showing may not be combined, except if specifically allowed such as in halter, showmanship, or lead-line.
8. “Type” refers to the conformation type of the horse. “Seat” refers to the equipment used on the horse.

9. There shall be no discrimination regarding the style of riding or type of horse being ridden.
10. In all classes involving saddle seat horses, the judge will not call for a canter from the trot.
11. All riding classes require an appropriate bridle unless specific class rules indicate otherwise.
12. Classes must be held in the same order as previously advertised and listed on the show bill.
13. Classes may be combined as show management deems necessary unless exhibitor(s) object or the classes can't be legally combined. Combined classes will be judged separately.
14. At show management's discretion, classes may be cancelled due to no entries or split due to a large number of entries.
15. Horses and ponies greater than 40" and Miniature/Pony 40" or less may not be combined in any driving event.
16. In halter classes where class specifications allow whips, the whip length may not exceed 6', including lash. For whip sizes in other appropriate classes, refer to the individual class specifications.
17. Any mounted performance class shall be shown astride unless otherwise noted.
18. The judge has the authority to excuse any equine from any class or event due to lameness, at any time during an event, competition, or show. This shall include, but not be limited to, lameness obviously observable at a trot, marked nodding, hitching or shortened stride, or minimal weightbearing in motion and/or at rest, or the inability to move.
19. In any performance class, an open leg wound may be covered by a bandage not to exceed 1½ wraps of vet wrap or similar materials and not over four (4) inches in width.
20. The use of artificial appliances or devices such as chains, shackles, rubber bands, blinkers (except when driving) or blindfolds are prohibited on the grounds before or during a competition.
21. Youth exhibitors may not be tied, buckled, or fastened in any way to a horse, or any portion of the tack, in any class – exception, a reasonable accommodation for a challenged exhibitor which necessitates such assistance.
22. A judge may severely penalize or excuse from the ring any person or horse for exhibiting bad conduct.
23. Any exhibitor may wear protective headgear in any division or class without penalty from the judge. ISHSA strongly encourages all riders to wear protective headgear passing or surpassing current applicable ASTM (American Society for Testing and Materials)/SEI (Safety Equipment Institute) standards with harness secured while riding anywhere on the competition grounds.
24. Proper tack is required at **all** shows.
25. Electronic communication devices used for purposes of coaching exhibitors, etc., between competitors and individuals outside the ring during a class, shall be

prohibited. Exempt from this rule are handicapped riders who have submitted written proof.

26. No award will be given to any competitor participating in any class while displaying the incorrect or no number for that turnout.
27. An equine may be entered only ONCE in per class. Age divisions are classes. So, an equine could be entered in “19-49 years” and “50 years and over” etc. but only once in each age division. Equines may go twice in one class if to break a tie—in the case of reining, trail, etc.
28. Unless a gate hold is called for or the class is preloaded, the gate will close two minutes after the first horse enters the ring or with large classes taking more than two minutes, the gate will close after the entrance of the final horse in a continuous string of horses. Every effort will be made to keep the exhibitors informed of gate calls, but it is the exhibitor’s responsibility to be ready and prepared to enter the ring, not show management or gate people.
29. For the purposes of horse showing, the age of the person on January 1 shall be maintained throughout the entire year.
30. COLTS/STALLIONS: Persons under the age of eighteen (18) are prohibited from showing colts or stallions in any ISHSA class including lead-line. For the purposes of showing, a “colt” is defined as any unaltered male equine under the age of four (4) and a “stallion” is defined as any unaltered male equine age four (4) and over. An altered male equine is defined as a gelding regardless of the equine’s age.
31. Accommodations for handicapped exhibitors must be submitted to the judge in advance of the classes in which the handicapped exhibitor is participating so that the necessary arrangements can be made.

Audits

1. An exhibitor may audit a class he/she is qualified to compete in if there is no present danger to the class as a result of the auditor auditing the class. Auditor will pay for the class. Auditor will wear his/her number upside down. Gimmicks or training devices will not be allowed. Proper tack and attire are required. The exhibitor will count, as a number for class points, however, will not be placed in the class. If the auditor chooses to school in the class, it is requested that the auditor stay in the center of the ring. He/she will not be allowed to stop on the rail or back into other competitors on the rail. Auditors must follow the class routine. Offenders will be excused from the ring. If offenses are repeated, the exhibitor will be asked to leave the show.

THIS PAGE INTENTIONALLY LEFT BLANK

Gait Calls

These are the terms that will be used for the gait calls in each respective division of classes.

Class	Gait Calls	Instructions
English Pleasure	Walk Trot Canter May ask to back May ask to hand gallop Any gait may be extended	<ol style="list-style-type: none"> 1. Must start class counterclockwise. 2. Saddle seat horses may not be asked to canter out of a trot.
English Equitation	Walk Trot Canter Back Any gait may be extended	<ol style="list-style-type: none"> 1. A walk, trot, and canter must be included except in walk/trot classes where no canter is allowed. 2. May be run as a rail, pattern, or rail and pattern class.
English Pleasure – Gaited Horse	Enter at the dog walk (not judged) counterclockwise. 1 st gait, 2 nd gait, 1 st gait, canter, 1 st gait, reverse direction to clockwise and continue with 1 st gait, 2 nd gait, 1 st gait, canter, 1 st gait. Back is required. May be called for on the rail during the class or in the lineup.	<ol style="list-style-type: none"> 1. Must be done in this order 2. 2-gait classes delete the canter from the sequence.
Western Pleasure	Walk Jog Lope May ask to back Any gait may be extended	<ol style="list-style-type: none"> 1. Must start class counterclockwise.
Horsemanship	Walk Jog Lope Back Any gait may be extended	<ol style="list-style-type: none"> 1. A walk, trot, and lope must be included except in walk/trot classes where no lope is allowed. 2. May be run as a rail, pattern, or rail and pattern class.

Western Pleasure— Gaited Horse	Enter at the dog walk (not judged) counterclockwise. 1 st gait, 2 nd gait, 1 st gait, lope, 1 st gait, reverse direction to clockwise and continue with 1 st gait, 2 nd gait, 1 st gait, lope, 1 st gait. Back is required. May be called for on the rail during the class or in the lineup.	<ol style="list-style-type: none"> 1. Must be done in this order. 2. 2-gait classes delete the lope from the sequence.
Reiner Rail	Walk or 1 st gait Jog or 2 nd gait Lope Must ask to stop & back Any gait may be extended	<ol style="list-style-type: none"> 1. Horses are to move like reining horses, not like western pleasure horses. 2. Must have completed one of the reining patterns.
Pleasure Driving	Walk Normal Trot Strong Trot Rein Back	<ol style="list-style-type: none"> 1. Must start class counterclockwise. 2. Headers allowed.
Reinsmanship (driving equitation)	Walk Collected Trot Normal Trot Strong Trot Rein Back	<ol style="list-style-type: none"> 1. This is a pattern class. Must use one of the ten patterns in the ISHSA rule book. 2. Enter one at a time from the gate.
Roadster Driving	Start clockwise at the jog trot, road gait, jog trot and reverse to counterclockwise and continue at the jog trot, road gait, trot at speed, jog trot to lineup. Rein Back is NOT allowed.	<ol style="list-style-type: none"> 1. Must start class clockwise. 2. Must be done in this order. 3. Headers allowed.

Ranch	Walk Trot Extended Trot Lope Extended Lope Back	Horses must be sound.
--------------	--	-----------------------

CONFORMATION CHARACTERISTICS

These conformation characteristics are to be used to determine in which classes a horse is to compete.

A. Stock Type Horse

1. The accepted breeding of the Stock Type Horse is a western horse of predominantly quarter horse breeding and conformation.
2. Halter classes – Stock Type entries are shown in a halter with lead shank. No assistants are permitted in the ring. Whip or crop is prohibited. Stock Type Horses shall stand squarely on all four (4) feet.
3. Entries shall be serviceably sound in all halter and performance classes.
4. Stock Type entries may be shown with natural, shortened or roached mane; natural or shortened tail. Tails may be lengthened by hair to hair attachment only with no attachments of any kind to the tailbone. The use of weighted tails is legal. Braiding or banding is permitted.

B. Stock Type Pony

1. The Stock Type Pony is a western type pony displaying the conformation associated with the quarter type horse and original style Shetland pony.

C. Hunter Type Horse

1. The accepted breeding of the Hunter Type Horse is an English horse of predominantly thoroughbred breeding and conformation. The “running style” quarter horse can also be found in this classification.
2. Entries shall be serviceably sound in all halter and performance classes.
3. Hunter Type entries may be shown with natural or shortened mane and tail. Roached mane is discouraged and may be penalized at the judge’s discretion. Braiding or banding in halter is allowed. In performance classes, Hunter Type entries may be braided according to the individual class specification.

D. Hunter Type Pony

1. The Hunter Type Pony is a pony reflecting the conformation associated with a thoroughbred type horse and Connemara pony. Certain bloodlines of Welsh pony can also be found in this classification.

E. Pleasure Type Horse

1. The accepted breeding of the Pleasure Type Horse is a horse of predominantly Arabian or Morgan breeding and conformation.
2. Entries shall be serviceably sound in all halter and performance classes. They may be shown barefoot or shod.
3. Pleasure type entries may be shown with natural, full, or shortened unset, ungingered tail and full or shortened mane in all classes. Roached mane or tail, tail brace, or cap is prohibited. Braiding is prohibited except in hunt seat and English showmanship classes, where Pleasure Type entries may be braided according to that individual class specification

F. Pleasure Type Pony

1. The Pleasure Type Pony is a pony reflecting the carriage and conformation associated with the Arabian and Morgan type horses and Welsh pony. Certain bloodlines of Shetland pony can also be found in this classification.

G. Saddle Type Horse

1. The accepted breeding of the Saddle Type Horse is an English horse of predominantly Saddlebred, Hackney, or Tennessee Walking Horse breeding and conformation, displaying the high head carriage and animated, high action of these breeds.
2. Entries shall be serviceably sound and shown without artificial appliances (e.g., wired ears) except inconspicuously applied hair in mane and tail or tail brace in all halter and performance classes.
3. If entries are braided, the horse shall be braided only in the Saddle Type manner. In performance classes, Saddle Type entries may be braided according to that individual class specification (hunter style braids are acceptable).

H. Saddle Type Pony

1. The Saddle Type Pony is a pony displaying the carriage, animation and action of the Saddlebred and Tennessee Walking Horses and modern style Shetland and Hackney ponies. Certain bloodlines of Welsh Pony can also be found in this classification.

I. Gypsy, Drum, and Draft Type Horse

1. Stock Type Horse rules apply except for specifications provided below.
2. The accepted breeding of the Gypsy Type is a horse of predominantly Gypsy Cob or Vanner breeding, displaying a heavy build with a short to moderate frame. No discrimination will be made regarding clipped and not clipped body hair. Gypsy Type Horse entries should exhibit feathering on legs.
3. Drum Type Horse is a horse of predominantly Gypsy crossbreeding with other draft type breeds, displaying a larger, taller frame, or full draft breeding. No discrimination will be made regarding clipped and not clipped body hair. Drum type utility horse entries should exhibit feathering on legs.
4. Draft Type Horse. No discrimination will be made regarding clipped and not clipped body hair. Draft Type horse entries should exhibit feathering on legs.

J. Mule

1. The general appearance of the mule should be:
 - a. Head straight with firm even mouth and jaw.
 - b. The eyes should be kind, bold and alert. Ears are well shaped with much length and attentive.
 - c. The mule should have a well-balanced head and neck of sufficient length that shows quality, blending into shoulders long and sloping well back.
 - d. Withers moderately defined and the same height as croup.
 - e. Chest should be broad and the forelegs set square, true, and strong with well modeled bones and good muscle.
 - f. Well sprung ribs, the back and loin short, wide and well-muscled.

- g. Underline is long with the flank well let down.
- h. Hips are smoothly covered being long, sloping and muscular.
- i. Hind legs should have hocks of good size, flat and clean to turn neither inward or outward.
- j. Hind legs not to be bent. Hocks not to be set behind a line from the point of the hip to the fetlock joint.
- k. Pasterns should have medium slope and length.
- l. Feet well shaped of medium size and sound.

K. Donkey

- 1. The general appearance of the donkey should be:
 - a. The neck should be well muscled, but not excessively thick, and of proportionate length.
 - b. The feet should be large and well cupped.
 - c. Bone should be of good size, flat and clean.
 - d. The legs should not be fine in appearance, resembling the leg of the thoroughbred horse.
 - e. Compared to a horse, the rump of a donkey has a sharper, more sloping croup. It should be strong and gently sloping.
 - f. The head should be well shaped and not of extreme length or thickness, tapering to a relatively fine, rounded muzzle, and be in good proportion to the body.
 - g. Large wide set eyes.
 - h. Well placed long, thin upright ears.

THIS PAGE INTENTIONALLY LEFT BLANK

ISHSA APPROVED CLASS LIST

Halter (Points are accumulated by the horse and not by the exhibitor.)

**See the halter section of the rule book for clarification of which class to compete in.

Breed	Stallion	Mare	Gelding
Quarter Horse (registered)	•	•	•
Pleasure/Saddle Type (registered ½ or better)	•	•	•
Paint/Pinto/Appaloosa (registered)	•	•	•
All Other Breeds (registered or grade)	•	•	•
Miniature/Pony (40" or less)	•	•	•
Champion & Reserve Champion 1 st & 2 nd from each breed specific class competes Non-year-end point earning class	•	•	•

Showmanship (Points are accumulated by the exhibitor and not by the horse.)

11 years and under walk/trot (may not cross enter)
13 years and under
14 – 18 years
19 – 49 years
50 years and over
Miniature/Pony (40" or less)
Walk/Trot limited rider (may cross enter into age group showmanship) Walk only

English equitation (Points are accumulated by the exhibitor and not by the horse.)

11 years and under walk/trot (may not cross enter)
13 years and under
14 – 18 years
19 – 49 years
50 years and over
Gaited Horse – 2 gait
Walk/Trot limited rider (may not cross enter)

Western horsemanship (Points are accumulated by the exhibitor and not by the horse.)

11 years and under walk/trot (may not cross enter)
13 years and under
14 – 18 years
19 – 49 years
50 years and over
Gaited Horse – 2 gait
Walk/Trot limited rider (may not cross enter)

Reinsmanship (driving equitation)

(Points are accumulated by the exhibitor and not by the horse.)

Miniature/Pony (40" or less)
Horse (greater than 40")

Lead-line equitation, 6 and under

(Participation is tracked on the exhibitor and not by the horse.)

Exhibitor may not cross-enter into anything other than showmanship and halter.

English pleasure – hunt or saddle seat

(Points are accumulated by the horse and not by the exhibitor.)

Walk/trot beginning horse—1 st year of showing English (may cross-enter)
Walk/Trot open (may cross-enter)
Walk/Trot limited rider (may not cross-enter)
Green horse – horse must be in its 1 st or 2 nd year of showing English anywhere
11 years and under walk/trot (may not cross enter)
13 years and under
14 – 18 years
19 – 49 years
50 years and over
Junior horse – 5 years and under
Senior horse – 6 years and over
Quarter Horse (registered)
Pleasure/Saddle Type (registered ½ or better)
Paint/Pinto/Appaloosa (registered)
All other horse, pony, and mule breeds (registered or grade)
Open
Gaited Horse – 2 gait – open
Gaited Horse – 3 gait – open
Disciplined rail

Driving

(Points are accumulated by the horse and not by the exhibitor.)

Pleasure driving – all ages -- (horse greater than 40")
Disciplined rail pleasure driving -- all ages--(horse greater than 40")
Pleasure driving – all ages -- miniature/pony (40" or less)
Disciplined rail pleasure driving -- all ages -- Miniature/Pony (40" or less)
Roadster driving – all ages--(horse greater than 40")
Roadster driving – all ages-- miniature/pony (40" or less)

Western pleasure

(Points are accumulated by the horse and not by the exhibitor.)

Walk/trot beginning horse—1 st year of showing western (may cross-enter)
Walk/Trot open (may cross-enter)
Walk/Trot limited rider (may not cross-enter)
Green horse – horse must be in its 1 st or 2 nd year of showing western anywhere
11 years and under walk/trot (may not cross enter)
13 years and under
14 – 18 years
19 – 49 years
50 years and over
Junior horse – 5 years and under
Senior horse – 6 years and over
Quarter Horse (registered)
Pleasure/Saddle Type (registered ½ or better)
Paint/Pinto/Appaloosa (registered)
All other horse, pony, and mule breeds (registered or grade)
Open
Gaited Horse – 2 gait – open
Gaited Horse – 3 gait – open
Disciplined rail

Trail

(Points are accumulated by the horse and not by the exhibitor.)

Walk/Trot open (may cross-enter)
Walk/Trot limited rider (may not cross-enter)
Green horse/green rider –horse must be in its 1 st or 2 nd year of showing western trail anywhere (within the last 10 years), or rider must be in his/her 1 st or 2 nd year of showing walk-jog-lope western trail anywhere.
11 years and under walk/trot (may not cross enter)
13 years and under
14 – 18 years
19 – 49 years
50 years and over
Gaited Horse — 2-Gait – Open
In-hand trail, 3 years and under – for horses greater than 40” not shown under saddle. Horse may only cross-enter into halter, showmanship, and driving.
In-hand trail, 3 years and under – for miniature/pony 40” or less not shown under saddle. Horse may only cross-enter into halter, showmanship, and driving.
In-hand trail, 4 years and over – for horses greater than 40” not shown under saddle. Horse may only cross-enter into halter, showmanship, and driving.
In-hand trail, 4 years and over – for miniature/pony 40” or less not shown under saddle. Horse may only cross-enter into halter, showmanship, and driving.

Western riding – all ages

(Points are accumulated by the horse and not by the exhibitor.)

Reining

(Points are accumulated by the horse and not by the exhibitor.)

18 years and under
19 years and over
Open
Reiner Rail -- limited to reining pattern participants

Gymkhana

(Points are accumulated by the horse and not by the exhibitor.)

	18 and under	19 and over	11 & Under Walk/Trot (may not cross enter)	Limited Rider Walk/Trot (may not cross enter)
Barrel racing	•	•	•	•
Pole bending	•	•	•	•
Key race	•	•	•	•
Figure 8 stake race	•	•	•	•
Flag race	•	•	•	•

Ranch

(Points are accumulated by the horse and not by the exhibitor.)

	18 and under	19 and over	Walk Trot
Ranch Trail	•	•	•
Ranch Riding	•	•	•
Ranch Reining	•	•	
Ranch Rail Pleasure	•	•	•
Ranch Conformation—stallions, geldings, mares combined			

General notes for all classes:

1. The term “horse” is used as a generality in reference all equines.
2. Horses may only be cross-entered in breed specific classes if the horse is double registered and has the appropriate registration papers.
3. When a specific breed is designated, horses may only compete in classes for which they are appropriately registered.
4. Those showing in the “11 years and under walk/trot (may not cross enter)” category may show mares or geldings in halter classes, but may not show in any other classes that don’t specifically have the title “11 years and under walk/trot (may not cross enter)”. Equines may cross enter.
5. Walk/Trot Limited Rider (may not cross enter) classes are restricted classes. Riders may not cross-enter into any class that involves loping or cantering. Riders may enter halter, showmanship age group, and walk/trot only classes, but are otherwise limited to classes with the title “Walk/Trot Limited Rider”. Equines may cross enter.
6. COLTS/STALLIONS: Persons under the age of eighteen (18) are prohibited from showing colts or stallions in any ISHSA class. For the purposes of showing, a “colt” is defined as any unaltered male equine under the age of four (4) and a “stallion” is defined as any unaltered male equine age four (4) and over. An altered male equine is defined as a gelding regardless of the equine’s age.
7. For the purposes of “Green” and “First Year Beginning Horse” classes, a “year of showing” equals showing, under saddle, under 4 or more judges within a calendar year.

THIS PAGE INTENTIONALLY LEFT BLANK

RULES FOR HALTER CLASSES

General:

Points are accumulated by the horse and not by the exhibitor.

Halter Judging

1. The judge should be aware of the fact that not all conformation types are traditionally shown in the same manner. Whereas Stock Types usually walk into the ring, Hunter Types may enter at a walk or a trot, at the judge's discretion, but must be trotted past the judge to allow assessment of soundness and length of stride. Pleasure and Saddle Types are normally brought into the ring at a trot, that gait being an important aspect of its conformation types.
2. Entries are to be judged on conformation, type, quality, and way of going with attention to the type of conformation and associated expectation in the case of classes not divided by type, and in the case of classes with separate sections for the four types. In judging Hunter Type halter horses, movement must be considered and suitable for purpose.
3. Judges may eliminate or severely mark down horses showing in a specific halter section (e.g., Pleasure Type) where, in the opinion of the judge, the horse is not a correct representative of that conformation type.
4. Blemishes, such as scars, splints, and spavins are to be marked down according to the effect on the soundness of the horse. Transmissible weakness and/or unsoundness are to be counted strongly against the horse.
5. Horses are to be shown in hand at a walk and jog or trot. Gaited horses are to be shown at 1st gait and 2nd gait.
6. A judge may penalize or disqualify an exhibitor for intentionally dropping the lead or excessively shanking an entry during halter or showmanship classes.
7. If a weanling/suckling entry is shown, it is permissible for the dam to accompany the foal into the arena, but the dam must be placed along the rail.
8. Exhibitor apparel should match the style of class.
9. Disqualifications
 - a. Lameness.
 - i. Obvious lameness is:
 1. Consistently observable at a trot under all circumstances;
 2. Marked nodding, hitching or shortened stride;
 3. Minimal weight-bearing in motion and/or at rest and inability to move.
 - b. Parrot/Monkey Mouth.
 - i. Defined as no occlusal contact between the upper and lower central incisors.
 - c. Cryptorchid.
 - i. Cryptorchidism in a stallion that is 2 years of age or older where there is evidence of only one testicle present.
 - d. Incorrect Pattern.

- i. All contestants that do not complete the prescribed pattern correctly in three attempts.
 - e. Setting Up-Inspection.
 - i. All contestants that do not get their horse set up and standing still for inspection long enough to allow for proper inspection of all 4 sides.
 - f. Loose Horse.
 - i. Any horse that becomes detached from its handler and is no longer under control shall be disqualified. If the initial horse exhibiting poor mannerisms causes other exhibitors to lose their horse, only the initiating horse can be disqualified. The decision of the judge will be final.
 - g. Disruptive Horse.
 - i. Any horse that is disruptive, or is a danger to the exhibitor, other exhibitors or horses, may be disqualified at the judge's discretion.
- 10. Stock Type Halter
 - a. Stock Type entries are shown in a plain or silver halter and lead shank. No assistants are permitted in ring. Whips and crops are prohibited.
 - b. Stock entries will stand squarely on all four feet.
 - c. Must follow western attire rules.
- 11. Hunter Type Halter
 - a. Hunter Type entries are shown in a snaffle bridle or leather halter and lead shank. In Hunter Type Halter classes, decorative silver bridles, monogrammed name plates and tags, and silver halters are prohibited. No assistants are permitted in the ring. Hunt whip or crop may be carried. Hunter Type Horses shall stand either in the traditional hunter position, with front feet square and hind feet offset, or square.
 - b. In Hunter Type halter, movement must be considered and suitable for purpose.
 - c. Attire:
 - i. Traditional and conservative hunt coat (no reds, pinks, bright colors, etc.), suitable breeches (no black or white), hunt shirt with stock tie or choker or oxford shirt with tie and helmet or hunt cap. Hunt bowler is also acceptable for adult exhibitors. Gloves are optional. It is optional that an exhibitor may wear a hard hat with harness in all classes.
 - ii. Or attire shall be a long sleeve collared dress shirt (solid colored and either white or another conservative color), dress pants or slacks, paddock boots or conservative tennis shoes. Blue jeans are prohibited. If a belt is worn, it should be a plain belt, not of western type or style. A non-Western hat, vest, coat, tie and gloves are optional.
- 12. Pleasure Type Halter
 - a. Pleasure type entries are shown in a halter with lead shank, show bridle with lead shank, or curb bit with rein. No assistants are permitted in the ring.
 - b. Whip is optional, but appendages are prohibited.

- c. Handlers shall be penalized for excessive use of a whip or actions with a whip that disturb any other entrant. Penalties may range from a warning to expulsion from the class.
 - d. Whip shall be slightly flexible and up to 72" in length, including lash.
 - e. Pleasure type entries shall stand squarely on all four feet or slightly stretched. Front legs must be perpendicular (at right angles) to the ground and all four feet flat on the ground. Rear legs may be placed squarely under the body or slightly offset (no more than one step). Judge may ask exhibitor to move hind leg(s) under entry for inspection.
13. Saddle Type Halter
- a. Saddle Type entries are shown in a show bridle with lead shank, curb bit or halter with lead shank. One assistant is allowed as a "tailer" in classes for Saddle Type only. Assistants are not allowed in classes where types are mixed.
 - i. Whip is optional for handler and assistant.
 - ii. Handlers shall be penalized for excessive use of a whip or actions with a whip that disturb any other entrant. Penalties may range from a warning to expulsion from the class.
 - iii. Whip shall be slightly flexible and up to 72" in length, including lash.
 - iv. Appendages will consist of a small, empty paper bag, a small empty plastic bag or ribbons.
 - b. Saddle Type entries may display a stretched or parked position when standing. It is recommended that the front legs be perpendicular to the ground or only moderately ahead (one step) of the perpendicular. When hind legs are placed behind the body it should be done without exaggeration or in any manner that would distort the horse's conformation. Judge may ask for repositioning of the horse.
14. Miniature/Pony Halter
- a. Type and Size Requirement
 - i. Miniature horse
 - ii. All types of ponies 40" and under
 - b. Refer to horse rules for further information for items not covered below.
 - c. Appointments - Refer to Horse rules and Horse classes
 - d. No whips, bats, or crops are permitted when showing a miniature
 - e. Miniatures are to be shown unshod in all classes and without weights of any kind. Any type of shoe or indication of shoes having been used, such as nail holes in the hooves of any miniature horse in the show ring, is strictly prohibited. Non-conforming entries must be eliminated.
 - f. The use of pads, wedges, chains or weighted ankle boots elastic bands, shackles, or other artificial appliances to enhance action are prohibited on the grounds before or during a competition.
15. Gypsy, Drum, and Draft Type Halter
- a. entries will enter the ring at a walk and will stand squarely on all four (4) feet.

16. Entering and competing in a halter section, or as a type other than the one shown on registration certificate, shall result in elimination from the class and loss of all awards and points from that class. The show committee is responsible for enforcement of this rule. If the show results indicate that any ineligible entrant has placed, ISHSA shall have the authority to make the appropriate corrections (i.e., eliminate the ineligible entrant and advance the placing of the remaining award winners.)
17. Appointments and handling of horse should be consistent with the type of horse being shown. The judge's emphasis is on conformation and type, but circumstances may occur where attire may vary with type being exhibited; discretion should be used by the judge before penalizing the entry.
18. In the halter division(s), if a championship is offered, the championship shall be awarded to one of the entries which has placed first in the qualifying class. After the championship has been awarded, the entry which has placed second in the qualifying class to the entry awarded the championship shall compete with the remaining first place winners for the reserve championship. Should any first-place winners in a qualifying class not compete for the championship, the second-place entry may be moved up for championship consideration.
19. Only the first and second place horses in a halter class, regardless of conformation type, sex, or age may compete for champion or reserve champion at halter.
20. Halter classes for all sexes, ages, and ISHSA divisions of horses must be offered on the show bill whenever halter classes are offered. All ages shall compete for championships if offered.

Proper Halter Class to Enter—points accumulated by the horse

Stock Horse Type (registered)	Appropriate breed class(es) based on official registration papers—Quarter Horse, Paint, Pinto, Appaloosa
Pleasure/Saddle Type (registered ½ or better)	Arabian, Morgan, Saddlebred, all gaited breeds, and Saddle/Pleasure type ponies taller than 40”
Miniature/Pony Type	Miniature horses and all ponies 40” or less
All Other Breeds	Any breed, registered or grade, that does not meet the above criteria. Gypsy, Drum, Draft, Mule, Donkey, Hunter Type breeds, and stock type ponies taller than 40”

1. Horses may cross enter into any class for which they are properly registered.
2. In the halter division only, Pleasure/Saddle Type includes the gaited horse breeds due to the style of showing. In all other divisions, gaited horses show in the “Gaited Horse” classes or in the appropriate age division for the rider/handler.

Halter Patterns

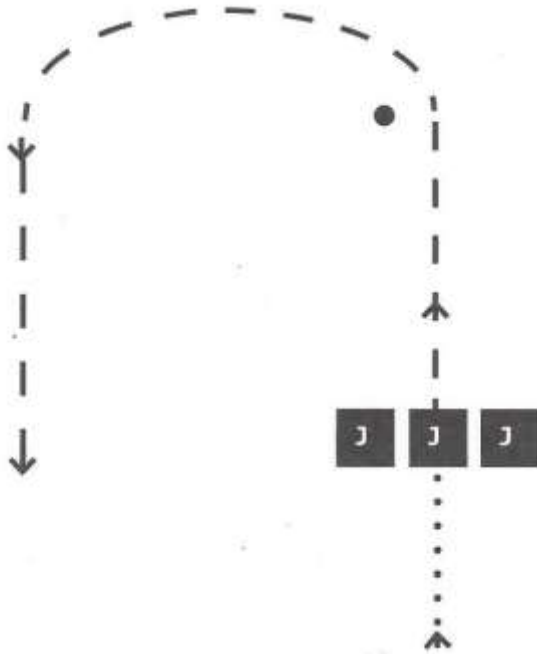

Stock Horse Type, Miniature/Pony 40'' or less, Stock Type ponies greater than 40'', and All Other Breeds will use this pattern.

1. Horses enter at the walk.
2. Stallions and mares stop at the judge(s) and show the horse's teeth to the judge. Stallions will be inspected for cryptorchidism. Geldings do not stop.
3. Horses pick up the trot and trot around the cone and line up head to tail for inspection as directed by the ring steward.
4. Judge(s) inspects all four (4) sides of the horse.

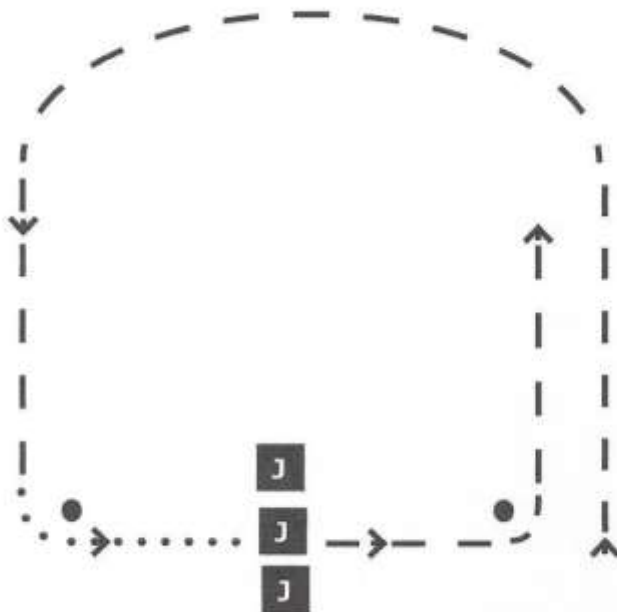

Pleasure and Saddle Types will use this pattern. (Includes all gaited breeds, and Saddle/Pleasure type ponies 40'' and taller.

1. Horses enter at the trot or 2nd gait.
2. Horses line up head to tail for initial inspection as directed by the ring steward.
3. Horses walk or 1st gait to the Judge(s) for inspection. Judge(s) inspects all four (4) sides of the horse.
4. Horses then trot or 2nd gait away from the judge, turn to the left and trot or 2nd gait back into line.

Championship Halter

If Championship Halter is offered, it shall be offered for Stallions, Geldings and Mares. The First Place and Second Place horse in each breed division may return for Championship Halter. It is suggested the First-Place horse from each breed class be lined up side-by-side, with the Second-Place horse (by breed) directly behind them, allowing adequate room for each breed to properly show according to their breed standards. In the event there is more than one judge, the horses shall be lined up for Judge A and judged, then Judge B, etc.

Grand Championship will be awarded to one of the horses which has placed first in a qualifying class. After the Championship has been awarded, the horse which has placed second in the qualifying class to the horse awarded the Championship, shall compete with the remaining first place winners for Reserve Championship.

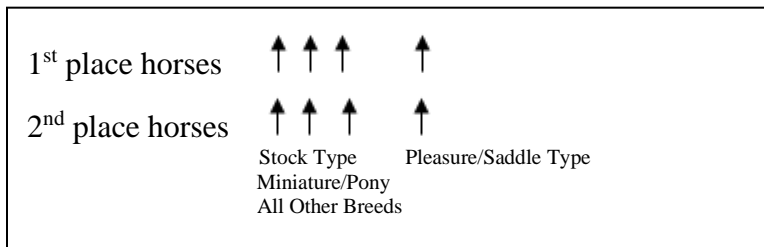

Class specifications:

See “*ISHSA Approved Class List*”.

Class default rule book: For situations that are not covered by the ISHSA rule book, ISHSA will default to the PtHA rule book for halter classes.

RULES FOR SHOWMANSHIP CLASSES

General

1. Points are accumulated by the exhibitor and not by the horse.
2. The showmanship at halter class is designed to evaluate the exhibitor's ability to execute, in concert with their horse, a set of maneuvers prescribed by the judge with precision and smoothness while exhibiting poise and confidence and maintaining a balanced, functional and fundamentally correct body position.
3. Showmanship patterns must be posted a minimum of one (1) hour prior to the class.
4. Exhibitors are only allowed to exhibit one (1) equine in each showmanship class.

Appearance

1. Attire and tack should be clean, well-fitting and in good repair. A workmanlike appearance should be presented. Attire should reflect the use of the equine and should be consistent with the tack used on the equine.
2. A hat is required in all classes.
3. Spurs are prohibited in all showmanship classes.

Grooming and Fitting of Animal

1. The equine should be prepared as if showing in a halter class for its conformation type.
2. The equine should be in good condition; the hair coat should be well-brushed; the mane and tail should be clean and free of tangles.
3. The feet should be properly trimmed; and if shod, the shoes should fit the animal properly and be securely and neatly fastened.

Presentation of Animal

1. Leading
 - a. The exhibitor should alertly lead the equine from the left side, holding the lead shank or rein in the right hand with the remaining portion of the shank or rein held neatly and safely in the left hand. The equine and exhibitor should readily perform the maneuvers called for by the pattern posted for the class.
 - b. All turns shall be to the right with the exhibitor walking to the right around the equine.
 - c. The judge will call on each exhibitor to move his/her equine individually. When moving the equine, exhibitors should be certain the judge can get a clean, unobstructed view of its action. The equine should move freely and in a straight line.
2. Posing
 - a. The exhibitor should set up the equine using a minimum of cueing, without touching the animal. The equine should be alert and posed (standing) to its best advantage for the judge's examination.
 - b. The exhibitor should leave a safe space between animals when lined up side by side or head to tail. equine should be allowed to stand quietly as the judge examines other animals in a line up. Over showing and undue maneuvering may be penalized.
3. Poise

- a. The exhibitor should present an alert, confident appearance. He/she should know the position of the judge at all times, respond quickly to direction from the judge or ring steward, and be courteous to other exhibitors.
- b. The exhibitor should quickly recognize and quietly correct faults made by the equine or the exhibitor.

Class Procedures

1. The judge may ask exhibitors to enter the ring and then work individual or work their patterns starting from the gate.
2. The following maneuvers are considered acceptable:
 - a. Lead the horse at a walk and trot. Gaited horses: 1st gait and 2nd gait.
 - b. Stops.
 - c. Turns of 90 (1/4), 180 (1/2), 270 (3/4), 360 (full turn) degrees or any combination or multiple of these turns. Pull turns are an unacceptable maneuver.
 - d. Back in a straight or curved line.
3. The judge must have each exhibitor set the horse up squarely for inspection during the class.

Western Showmanship

1. Equines shall be shown in a halter with lead shank. Leather equipment is suggested and preferred over other materials. Silver is optional.
2. Whips or crops are prohibited.
3. Equines used in a western showmanship class shall stand according to its conformation type regulations.
 - a. A judge may ask a showmanship exhibitor to square up his/her equine for individual inspection.
 - b. An equine posed in any other manner shall be marked down.
4. In western showmanship, any type of equine may be braided or banded.
5. Suitable western attire shall be worn while using approved western tack. (Refer to *“Rules for Western Pleasure Classes”*)

English Showmanship

1. Equines shall be shown in a plain leather halter with lead shank, show bridle with lead shank, a snaffle bridle or curb bit. In all cases, leather equipment is suggested and preferred over other materials. Decorative silver bridles and silver halters are prohibited.
2. Whips or crops are optional, and must be suitable for the type of equine exhibited. A whip shall not be used as a substitute for proper training. Exhibitors shall be penalized for actions with a whip that disturb any other exhibitor.
3. Suitable English attire shall be worn and shall match the type presented, i.e. hunt seat or saddle seat. (Refer to *“Rules for English Pleasure Classes”*)
4. Equine used in an English showmanship class must be shown according to its conformation type regulations.
5. In English showmanship, any type of equine may be braided.

SCORING RUBRIC

Scores range from -3 to +3. 0 denoting correct but no degree of difficulty.
Scoring starts at 70 with a final score of 0 to +5 given for form and effectiveness.

Penalties

3 points

- Break of gait at a walk or trot for up to two strides
- Over or under turning up to 1/8 of a turn
- Ticking or hitting cone
- Sliding a pivot foot
- Lifting a pivot foot during a pivot and replacing it in the same place
- Lifting a foot and replacing it in the same place after presentation

5 points

- Not performing the gait or not stopping within 10 feet of designated area
- Break of gait at walk or trot for more than 2 strides
- Splitting the cone (cone between horse and handler)
- Horse stepping out of set-up after presentation
- Horse stepping out of or moving the hind end significantly during a pivot or turn
- Over or under turning 1/8 to 1/4 turn

10 points

- Exhibitor is not in the required position during inspection
- Exhibitor touching the horse or kicking or pointing their feet at the horse's feet during the setup
- Standing directly in front of the horse
- Loss of lead shank, holding chain, or two hands on shank
- Severe disobedience to include but not limited to: biting, pawing, rearing, kicking out, or continuously circling the exhibitor
- Completely stepping out of the pivot and/or failing to perform or complete the maneuver with a pivot foot.

Disqualifications (0 score): An entry shall be disqualified by the judge on the basis of going off pattern or course, or knocking down or refusing obstacles. These entries count as official entries.

Class specifications:

See *"ISHSA Approved Class List"*.

Class default rule book: For situations that are not covered by the ISHSA rule book, ISHSA will default to the PtHA rule book for showmanship classes. To stay compliant with changes in the equine industry, ISHSA will add or subtract obstacles and or scoring rules for showmanship immediately following the lead of such changes made by the Pinto Horse Association. ISHSA will follow suit without needing to specifically vote on the changes.

It is suggested that judge(s) post their score sheets following the completion of the class(es).

Pattern Class Score Sheets are available on the AQHA website.

RULES FOR EQUITATION CLASSES

Equitation, Horsemanship, Reinsmanship (driving equitation), and Lead-line

General Regulations and Requirements

1. Points are accumulated by the exhibitor and not by the horse.
2. This division is divided into four (4) distinct sections – English equitation (hunter seat equitation/saddle seat equitation combined), western horsemanship, reinsmanship (driving equitation), and lead-line equitation, 6 & under. In these classes, only the exhibitor is being judged. Horses, attire, and equipment must be consistent with class specifications.
3. Any exhibitor not having his/her mount under sufficient control shall be dismissed from the ring and shall be disqualified from that class. In western horsemanship, hunter seat equitation on the flat, saddle seat equitation, lead-line equitation, and reinsmanship; the fall of horse or exhibitor shall not necessarily eliminate, but may be penalized at the judge's discretion.
4. No attendant shall be allowed in the ring except at the request of the judge.
5. Equitation and horsemanship classes may be conducted as a rail class, as a pattern class, or as a combination rail and pattern class at the judge's discretion. These classes must include walk/1st gait, jog/trot/2nd gait, and lope/canter component except in walk/trot classes, which will only have walk/1st gait and jog/trot/2nd gait components.
6. If used, patterns shall be publicly posted at least one (1) hour prior to class.
7. Junior horses shown in a bosal or snaffle bit must be ridden with two hands in horsemanship classes.
8. An exhibitor may show only one (1) entry per class.
9. ISHSA will combine hunter seat and saddle seat equitation into English equitation.
10. Reinsmanship classes will be conducted using one (1) of the ten (10) patterns included in this section. No other patterns will be allowed.

HUNTER SEAT EQUITATION

1. Tack and Attire
 - a. Attire and equipment will be the same as in English pleasure.
 - b. Clothing must be clean, workmanlike, and neat.
 - c. The saddle must fit the exhibitor.
 - d. A judge may penalize a horse with non-conventional types of bits or nose bands.
 - e. Boots or bandages are prohibited in all classes and martingales are prohibited in classes not to jump (flat classes).
 - f. Spurs must be of the unrowelled type.
 - g. Crops or bats are optional and must not exceed thirty (30) inches.
2. Hands/Reins
 - a. Hands should be over and in front on horse's withers, knuckles 30° inside the vertical.
 - b. Hands are slightly apart and making a straight line from horse's mouth to exhibitor's elbow.

- c. Method of holding reins is optional, and the excess rein may fall on either side. However, all reins must be picked up at the same time.
3. Basic position
 - a. The eyes should be up and shoulders back.
 - b. Toes should be at an angle best suited to exhibitor's conformation; ankle flexed in, heels down, calf of leg in contact with horse and slightly behind girth.
 - c. Iron may be either on toe, ball of foot or "home".
4. Position in Motion
 - a. At the walk and sitting trot, body should be vertical
 - b. Posting trot, body inclined forward
 - c. Canter, body is half way between the posting trot and the walk
 - d. Galloping, body is at the same inclination as the posting trot.
5. Class Routine
 - a. May be conducted as a rail class, as a pattern class, or as a combination rail and pattern class at the judge's discretion.
 - b. If conducted as a pattern class, exhibitors may be worked individually from the gate or they may all enter at once and then work individually.
 - c. If rail work is required, on command, the order to reverse may be executed by turning either toward or away from the rail.
 - d. Exhibitors may be asked to work collectively without irons.
 - e. Light contact with horse's mouth is required.
 - f. Exhibitors shall not be asked to change mounts.
 - g. Must include a walk/1st gait, trot/2nd gait, and canter component except in walk/trot classes, which will only have walk/1st gait and trot/2nd gait components.
6. Additional Work
 - a. Exhibitors will perform not only the ring routine demanded of his/her, but also should be able to perform whatever additional tests from those listed below that the judge may deem advisable.
 - b. All tests must be performed on the flat.
 - c. Tests may be performed either collectively or individually, but no other test may be used.
 - i. Halt.
 - ii. Back.
 - iii. Hand gallop.
 - iv. Figure eight at canter on correct lead, demonstrating simple change of lead. (This is a change whereby the horse is brought back into a walk or trot and restarted into a canter on the opposite lead.) Figures to be commenced in center of two (2) circles so that one (1) change of lead is shown.
 - v. Disengage feet from irons. Ride without irons for a brief period of time. Engage feet in irons.
 - vi. Turns on the forehand.
 - vii. Figure eight at canter on correct lead, demonstrating flying change of lead (This is a change whereby the horse remains at the canter and switches to the opposite lead).

- viii. Execute serpentine at a trot demonstrating correct diagonals.
- ix. Execute serpentine at the canter on correct lead, demonstrating simple or flying changes of lead.
- x. Change leads down center of ring (or on a line), demonstrating a simple or flying change of lead.
- xi. Canter on counter lead.
- xii. Turns on the haunches.
- xiii. Execute circles of various sizes and speeds.
- xiv. Side pass.
- xv. Any safe and negotiable combinations of the above.
- xvi. The use of cones or similar objects as markers is acceptable.

7. Judging

- a. Exhibitors to be judged on seat, hands, performance of horse. Appointments and suitability also to be considered.
 - b. The required equitation seat should in no way be exaggerated, but be thoroughly efficient and most comfortable for riding the type of horse called for at any gait and for any length of time.
 - c. Exhibitors should convey the impression of effective and easy control. To show a horse or pony well, he/she should show to his/her best advantage.
 - d. Ring generalship shall be taken into consideration by the judge. Generalship should constitute ring presence, management, style, and confidence.
8. Scoring: refer to the scoring rubric for English Equitation and western horsemanship. It is suggested by ISHSA that judge's post their score sheets.

SADDLE SEAT EQUITATION

1. Tack and Attire

- a. Attire and equipment shall be the same as in English pleasure
- b. The saddle must fit the exhibitor.
- c. Forward seat or western saddles are prohibited.
- d. Martingales or tie-downs are prohibited.

2. Hands/Reins

- a. Hands should be held in an easy position, neither perpendicular nor horizontal to the saddle, and should show sympathy, adaptability and control.
- b. The height the hands are held above the horse's withers is a matter of how and where the horse carries its head.
- c. The method of holding the reins is optional, except that both hands shall be used and all reins must be picked up at one time.
- d. Bight of rein should be on the off side.

3. Basic Position of Exhibitor

- a. To obtain proper position, exhibitor should place him/herself comfortably in the saddle and find his/her center of gravity by sitting with a slight bend at the knees, but without use of irons. While in this position, adjust leather to fit.
- b. Irons should be placed under ball of foot (not toe nor "home"), with even pressure on entire width of sole and center of iron. Foot position should be natural (neither extremely in nor out).

4. Position in Motion
 - a. At the walk, there should be slight motion in the saddle.
 - b. At the trot, slight elevation in saddle posting; hips under body, not mechanical up-and-down, nor swinging forward and backward.
 - c. At the canter, close seat and going with horse.
5. Class Routine – Same as Hunter Seat Equitation
6. Additional Work – Same as Hunter Seat Equitation
7. Judging – Same as Hunter Seat Equitation
8. Scoring – Same as Hunter Seat Equitation

WESTERN HORSEMANSHIP

1. Tack and Attire
 - a. Attire and equipment shall be the same as in western pleasure.
 - b. Clothing must be clean, workmanlike, and neat.
 - c. The saddle must fit the exhibitor. It may be slick or swelled fork, have a high or low cantle, but must definitely be sized to the exhibitor.
 - d. Nothing that would prevent the stirrups from hanging freely shall be added to or deleted from a standard western saddle.
2. Hands/Reins
 - a. In repose, arms are in a straight line with body, the one holding reins bent at elbow.
 - b. Only one (1) hand is to be used for reining and hands shall not be changed. (Exception: Junior horses shown in a bosal/ hackamore or snaffle bit must be ridden with two hands.)
 - c. The position of the hand not used for reining is optional, but it should be kept free of horse and equipment and held in a relaxed manner.
 - d. Hands to be above horn and as near to it as possible.
 - e. Bracing against horn, coiled riata or rope will be penalized.
3. Basic position
 - a. The exhibitor should sit in the saddle in a balanced, relaxed manner, with legs hanging straight and slightly forward to the stirrups.
 - b. The stirrup should be just short enough to allow heels to be lower than toes.
 - c. Body always should appear comfortable, relaxed and flexible.
 - d. Feet should be placed in the stirrups with weight on ball of the foot. Consideration, however, should be given to the width of the stirrups, which vary on western saddles. If stirrups are wide, the foot may have appearance of being “home” when, in reality, the weight is being properly carried on the ball of the foot.
4. Position in Motion
 - a. Exhibitor should sit the jog. No posting.
 - b. At the lope, he/she should be close to saddle.
 - c. All movements of the horse should be governed by the use of imperceptible aids.
 - d. The shifting of exhibitor’s weight is not desirable.

5. Class Routine

- a. May be conducted as a rail class, as a pattern class, or as a combination rail and pattern class at the judge's discretion.
- b. If conducted as a pattern class, exhibitors may be worked individually from the gate or they may all enter at once and then work individually.
- c. If pattern is not worked first, enter the ring at a walk or jog
- d. If rail work is required, on command, the order to reverse may be executed by turning either toward or away from the rail.
- e. Light contact with horse's mouth is required.
- f. Exhibitors shall not be asked to change mounts.
- g. Must include a walk/1st gait, jog/2nd gait, and lope component except in walk/trot classes, which will only have walk/1st gait and jog/2nd gait components.

6. Additional Work

- a. Exhibitors will perform not only the ring routine demanded of his/her, but also should be able to perform whatever additional tests from those listed below that the judge may deem advisable.
- b. Tests may be performed either collectively or individually, but no other test may be used.
 - i. Back
 - ii. Stop
 - iii. Change leads down the center of the ring (or on a line), demonstrating simple change of lead or flying change of lead.
 - iv. Individual performance on the rail.
 - v. Execute various degree turns example: 90°, 180°, 270°, etc.
 - vi. Figure eight at a jog.
 - vii. Lope and stop.
 - viii. Figure eight at lope on correct lead, demonstrating simple change of lead. (This is a change whereby the horse is brought back into a walk or jog and restarted into a lope on the opposite lead.) One (1) figure eight demonstrates one (1) change of lead and is completed by closing up the last circle and stopping in the center of the eight.
 - ix. Ride without stirrups.
 - x. Figure eight at lope on correct lead, demonstrating flying change of lead.
 - xi. Change leads down center of ring, demonstrating simple change of lead.
 - xii. Ride serpentine course, demonstrating flying change of lead at each change of direction. (Flying lead change is a change where the horse remains at the lope and switches to the opposite lead).
 - xiii. Demonstrate sliding stop.
 - xiv. Execute 360° turns (spins).
 - xv. Roll backs.
 - xvi. Execute circles of various sizes and speeds.
 - xvii. Side pass.
 - xviii. Any safe and negotiable combinations of the above.
 - xix. The use of cones or similar objects as markers is acceptable.

7. Judging

- a. Exhibitors to be judged on seat, hands, performance of horse. Appointments and suitability also to be considered.
 - b. The required equitation seat should in no way be exaggerated, but be thoroughly efficient and most comfortable for riding the type of horse called for at any gait and for any length of time.
 - c. Exhibitors should convey the impression of effective and easy control. To show a horse or pony well, he/she should show to his/her best advantage.
 - d. Ring generalship shall be taken into consideration by the judge. Generalship should constitute ring presence, management, style, and confidence.
8. Scoring: refer to the scoring rubric for English equitation and western horsemanship. It is suggested by ISHSA that judge's post their score sheets.

SCORING RUBRIC – ENGLISH EQUITATION AND HORSEMANSHIP

Scores range from -3 to +3. 0 denoting correct but no degree of difficulty.
Scoring starts at 70 with a final score of 0 to +5 given for form and effectiveness.

Penalties

3 points

- Tick or hit of cone
- Over or under turn from 1/8 to 1/4
- Break of gait from a walk, jog or trot up to two strides
- Obviously looking down to check leads or diagonal

5 points

- Incorrect lead or break of gait (except when correcting an incorrect lead) at the lope
- Not performing the specific gait or not stopping when called for in the pattern within 10 feet of the designated location
- Break of gait at walk, jog or trot for more than 2 strides
- Missing a diagonal for one to two strides in the pattern or on the rail
- Loss of iron or stirrup
- Head carried too low and/or clearly behind the vertical while the horse is in motion, showing the appearance of intimidation
- Complete loss of contact between the rider's hand and the horse's mouth

10 points

- Loss of rein
- Missing a diagonal for more than two strides
- Use of either hand to instill fear or praise while on pattern or during rail work
- Grabbing the saddle horn or any other part of the saddle
- Cueing with the end of the romal
- Spurring in front of the cinch or using the crop in front of the girth
- Blatant disobedience including kicking, pawing, bucking, and rearing

Disqualifications (0 score): An entry shall be disqualified by the judge on the basis of going off pattern or course, or knocking down or refusing obstacles. These entries count as official entries.

It is suggested that judge(s) post their score sheets following the completion of the class(es).

Pattern Class Score Sheets are available on the AQHA website.

REINSMANSHIP EQUITATION (driving equitation)

1. General Regulations and Requirements
 - a. Reinsmanship is a driving equitation class in which exhibitors are judged on suitability and skill of the driver.
 - b. The horse is to be shown in a harness suitable to the vehicle used.
 - c. The vehicle should be an appropriate two (2) or four (4) wheeled vehicle with wire or wooden wheels and in sound condition.
2. Attire and Appointments
 - a. Appointments of driver and attendant (header); the driver and attendants (if any) should be dressed conservatively according to the style of the present day.
 - b. Suggested attire for gentlemen, dress pants and shirt, coat or jacket and boots.
 - c. Suggested attire for ladies; long sleeved and conservative dress, tailored suit, skirt or slacks with long sleeved blouse, with vest or jacket and boots.
 - d. The following is required of all drivers: hat or protective headgear and whip in hand.
 - e. Lap apron or robes are optional.
 - f. Attendants should wear long pants, shirt, and boots.
3. Gaits to be shown at
 - a. Walk
 - b. Collected trot
 - c. Normal trot
 - d. Strong trot (extended)
4. Judging
 - a. Seventy-five (75) percent on handling of reins and whip, control, posture, and overall appearance of the driver.
 - b. Twenty-five (25) percent on the condition of the harness and vehicle and neatness of attire.
5. Class Conduct
 - a. This class will be conducted as a pattern only class.
 - b. Drivers will enter the ring individually and complete the posted test (pattern) in the order and at the prescribed pace.
 - c. The test (pattern) to be used must be chosen from the patterns listed in the ISHSA rule book. The test should be posted at least one (1) hour prior to the start of the class.
 - d. The judging for all reinsmanship tests begins when the entry enters the ring/test area.
6. Scoring: refer to the scoring rubric for reinsmanship (driving equitation). It is suggested by ISHSA that judge's post their score sheets.

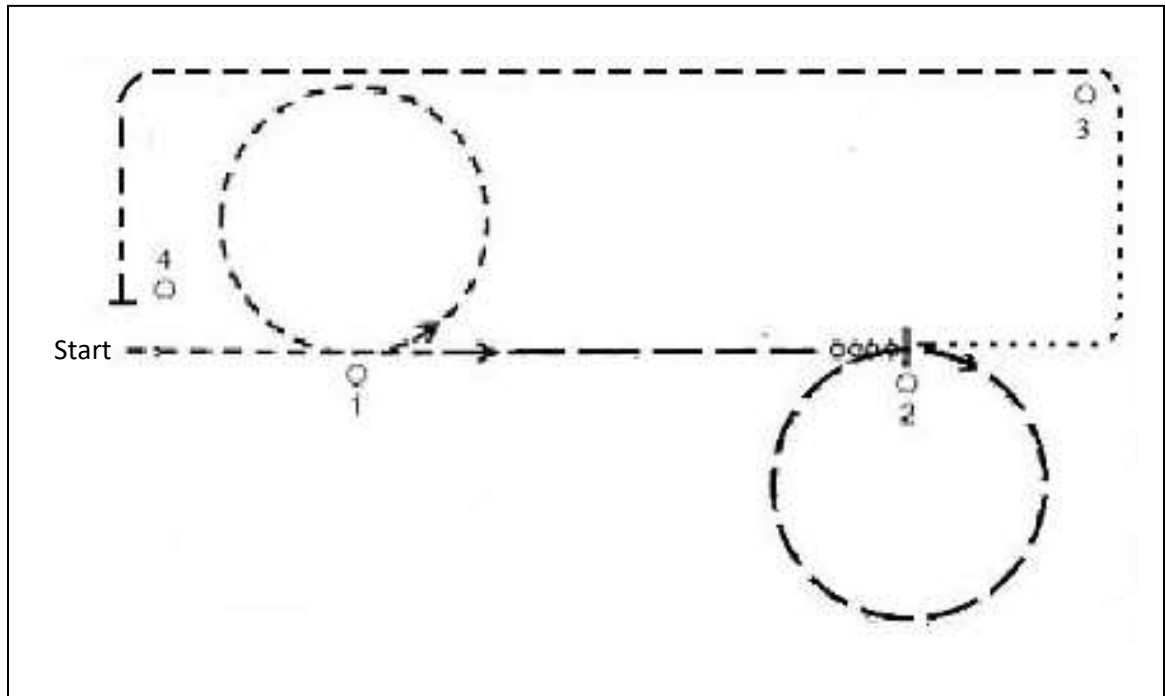

Reinsmanship Test 1

Test Elements: (10 points each)

1. Enter at the collected trot. At marker 1, circle left approximately 70 feet.
2. Normal trot from marker 1 to marker 2. Circle right approximately 70 feet.
3. At marker 2, halt for 5 seconds. Rein back 4 steps.
4. Walk forward toward the rail, track left to marker 3.
5. Develop a collected trot at marker 3, continue along the rail to marker 4.
6. Halt, leave arena at walk.
7. Overall impression of the turnout on the condition and fit of the harness and vehicle, neatness of attire.
8. General impression of the driver on posture, relaxation, confidence, and effectiveness.

Perfect score = 80 points

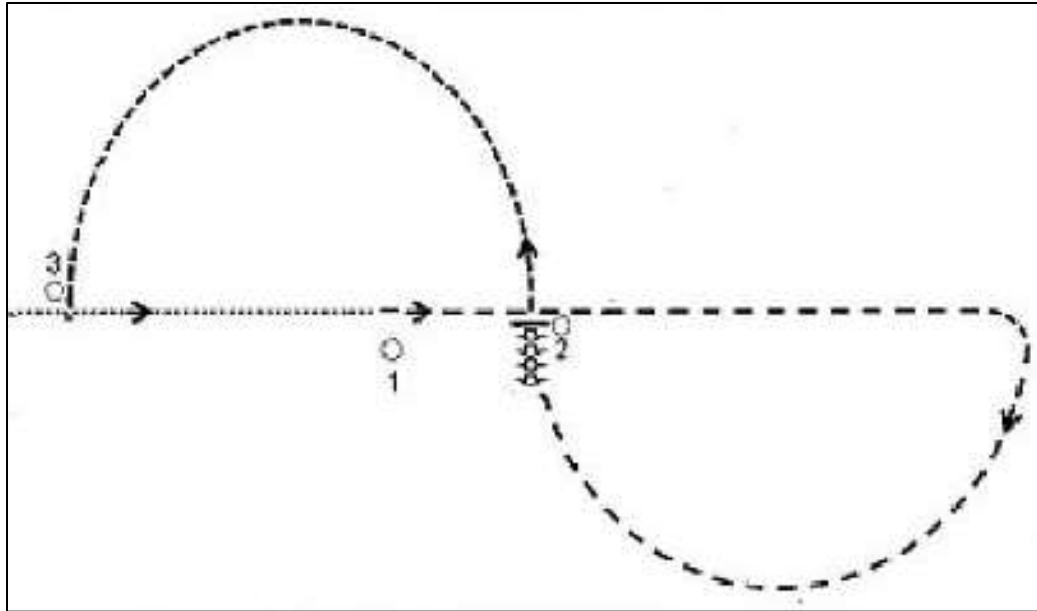

Reinsmanship Test 2

Test Elements: (10 points each)

1. Enter at the walk, continue to marker 1.
2. Develop a normal trot at marker 1, tracking right at the rail. Half circle to the right to marker 2.
3. At marker 2, halt.
4. Rein back 4 steps, walk forward.
5. At marker 2, develop a collected trot; continue half circle to the left to marker 3.
6. Halt, leave arena at walk.
7. Overall impression of the turnout on the condition and fit of the harness and vehicle, neatness of attire.
8. General impression of the driver on posture, relaxation, confidence, and effectiveness.

Perfect score = 80 points

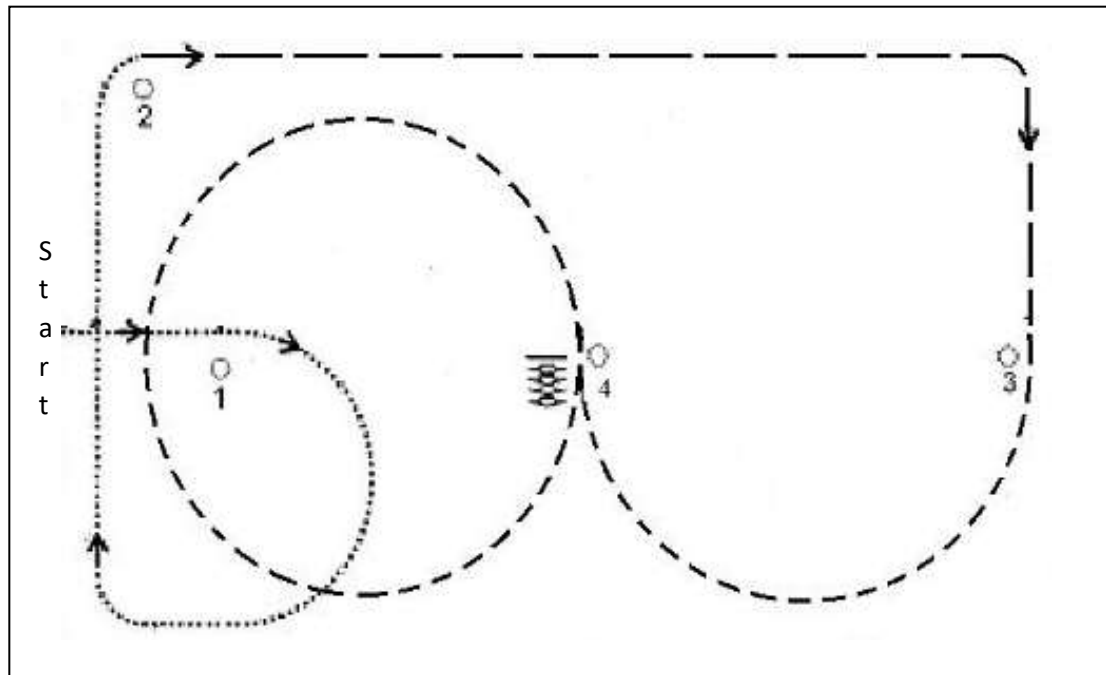

Reinsmanship Test 3

Test Elements: (10 points each)

1. Enter at the walk, continue to marker 1.
2. Track right at the walk to the rail, continue to marker 2.
3. At marker 2, normal trot along the rail to marker 3.
4. At marker 3, collected trot half circle right approximately 130 feet.
5. At marker 4, collected trot circle left approximately 130 feet.
6. At marker 4, halt, rein back 4 steps.
7. Walk to the exit.
8. Overall impression of the turnout on the condition and fit of the harness and vehicle, neatness of attire.
9. General impression of the driver on posture, relaxation, confidence, and effectiveness.

Perfect score = 90 points

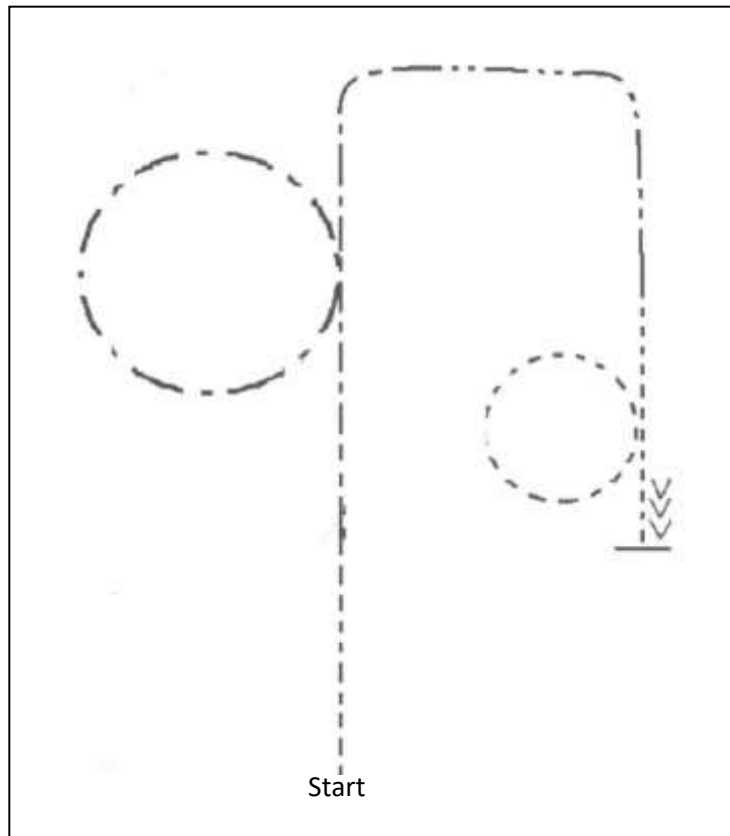

Reinsmanship Test 4

Test Elements: (10 points each)

1. Collected trot down the center.
2. Develop a normal trot; medium circle to the left.
3. Normal trot around the rail; collected trot.
4. Collected trot small circle to right.
5. Halt, rein back 4 steps.
6. Walk to the exit.
7. Overall impression of the turnout on the condition and fit of the harness and vehicle, neatness of attire.
8. General impression of the driver on posture, relaxation, confidence, and effectiveness.

Perfect score = 80 points

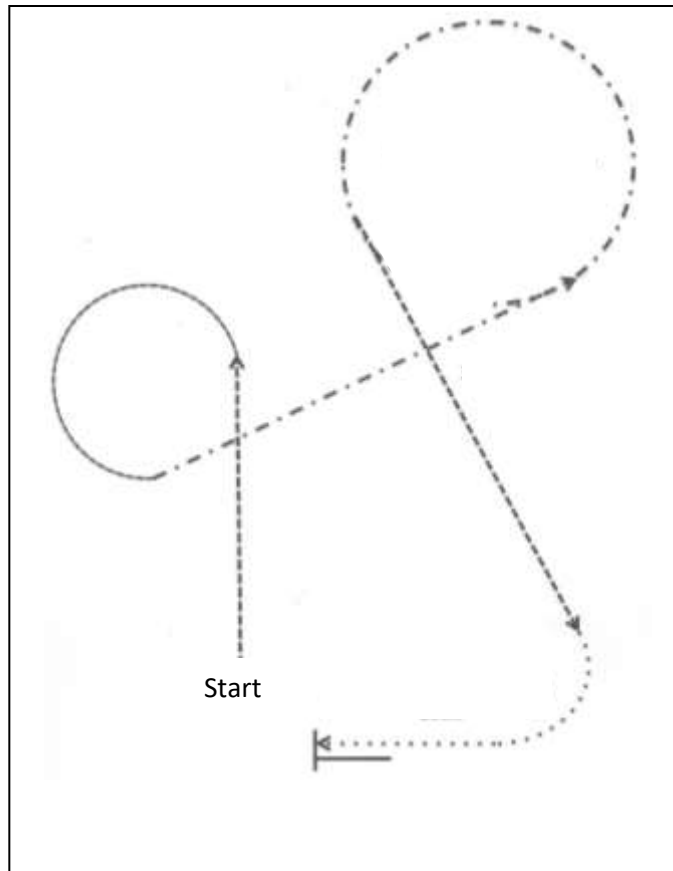

Reinsmanship Test 5

Test Elements: (10 points each)

1. Enter at the collected trot, collected trot small circle left.
2. Develop a normal trot straight line; medium circle to the left.
3. Collected trot straight line.
4. Walk corner to the right, halt, rein back 4 steps.
5. Walk to the exit.
6. Overall impression of the turnout on the condition and fit of the harness and vehicle, neatness of attire.
7. General impression of the driver on posture, relaxation, confidence, and effectiveness.

Perfect score = 70 points

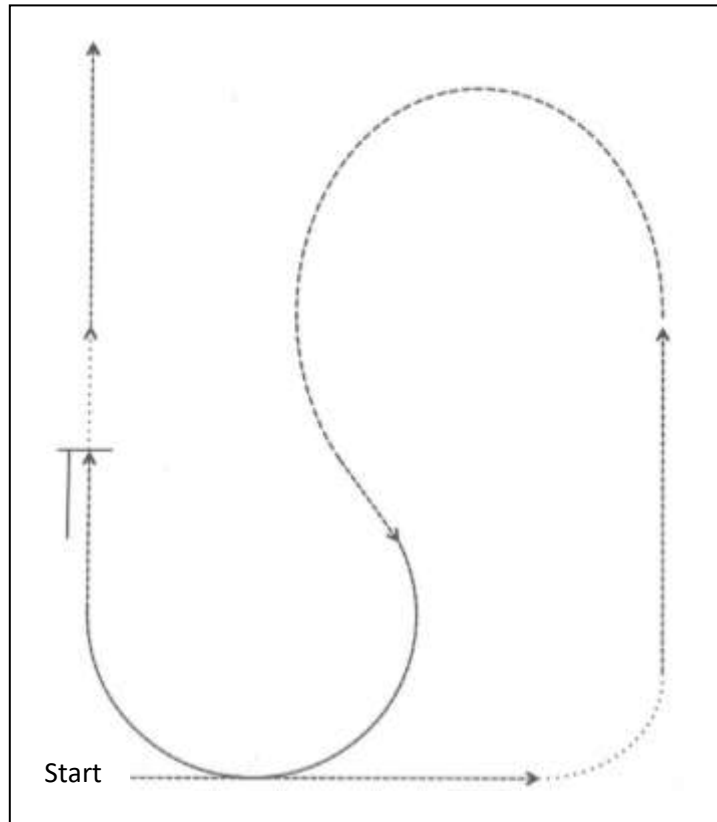

Reinsmanship Test 6

Test Elements: (10 points each)

1. Enter at the collected trot, collected trot across the arena.
2. Walk corner, collected trot.
3. Normal trot 5/8 circle, collect trot.
4. Collected trot 1/2 circle as shown.
5. Halt, rein back 4 steps.
6. Walk 7 steps, collected trot to the exit.
7. Overall impression of the turnout on the condition and fit of the harness and vehicle, neatness of attire.
8. General impression of the driver on posture, relaxation, confidence, and effectiveness.

Perfect score = 80 points

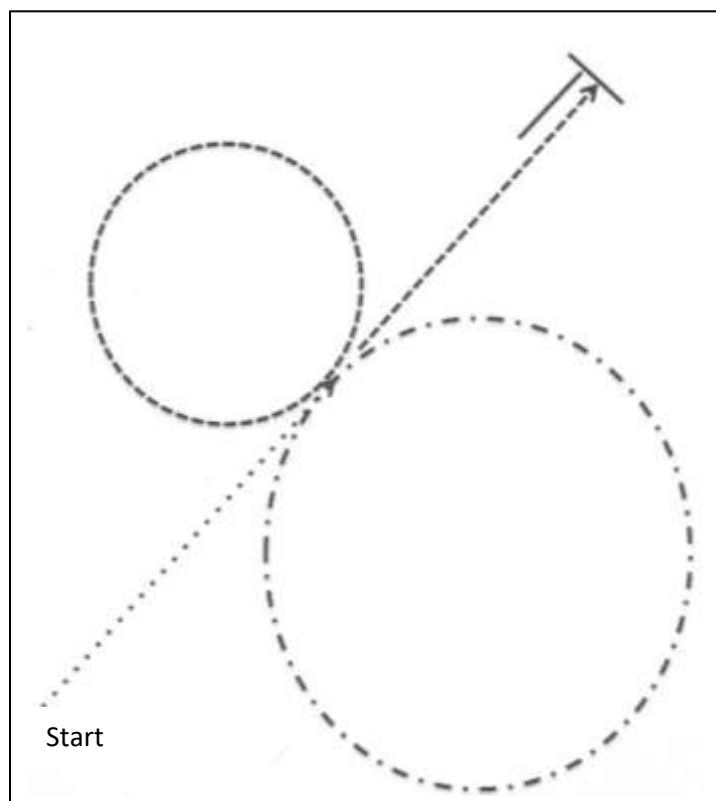

Reinsmanship Test 7

Test Elements: (10 points each)

1. Enter at the walk, walk diagonally across the arena.
2. Collected trot circle left.
3. Normal trot circle right.
4. Collect trot.
5. Halt, rein back 4 steps.
6. Collected trot to the exit.
7. Overall impression of the turnout on the condition and fit of the harness and vehicle, neatness of attire.
8. General impression of the driver on posture, relaxation, confidence, and effectiveness.

Perfect score = 80 points

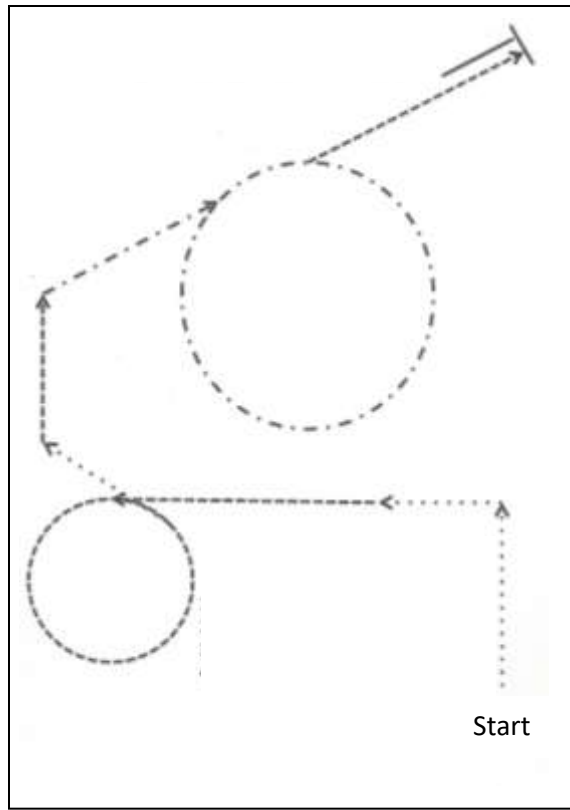

Reinsmanship Test 8

Test Elements: (10 points each)

1. Enter at the walk, walk a square corner as shown.
2. Collected trot across arena, circle left.
3. Collected trot, gradually moving into a normal trot.
4. Circle right.
5. At the close of the circle, collect to the collected trot.
6. Halt, rein back 4 steps.
7. Collected trot to the exit.
8. Overall impression of the turnout on the condition and fit of the harness and vehicle, neatness of attire.
9. General impression of the driver on posture, relaxation, confidence, and effectiveness.

Perfect score = 90 points

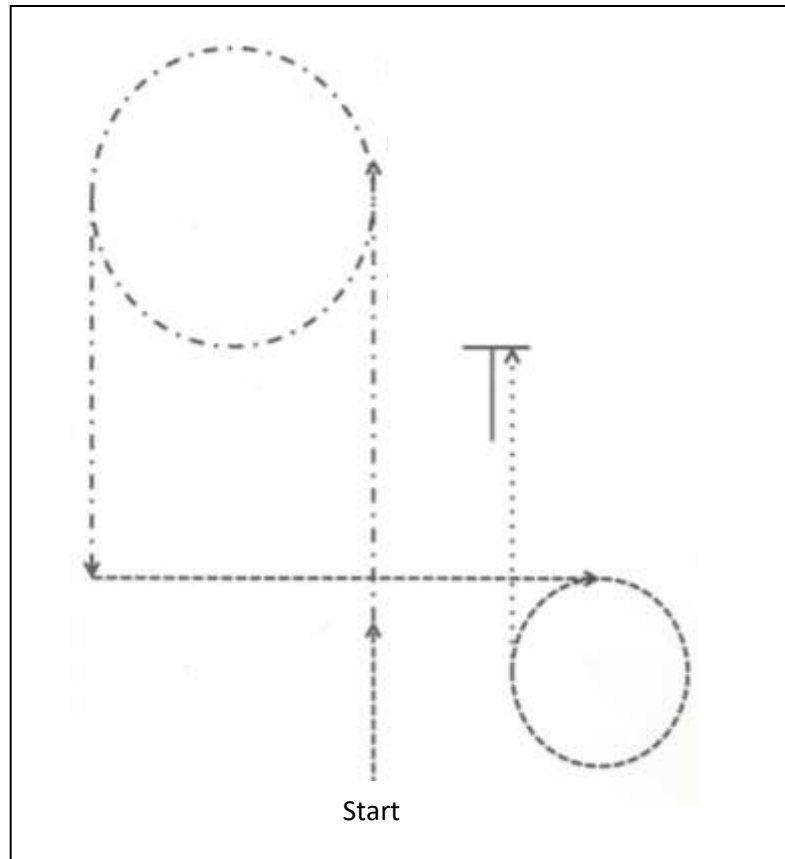

Reinsmanship Test 9

Test Elements: (10 points each)

1. Enter at the collected trot, collected trot up the center of the arena gradually moving into a normal trot.
2. Perform 1 ½ circles left, continuing at the normal trot down the line.
3. Turn left, collected trot line, 1 ¾ circles right.
4. At the close of the circle, walk.
5. Halt, rein back 4 steps.
6. Collected trot to the exit.
7. Overall impression of the turnout on the condition and fit of the harness and vehicle, neatness of attire.
8. General impression of the driver on posture, relaxation, confidence, and effectiveness.

Perfect score = 80 points

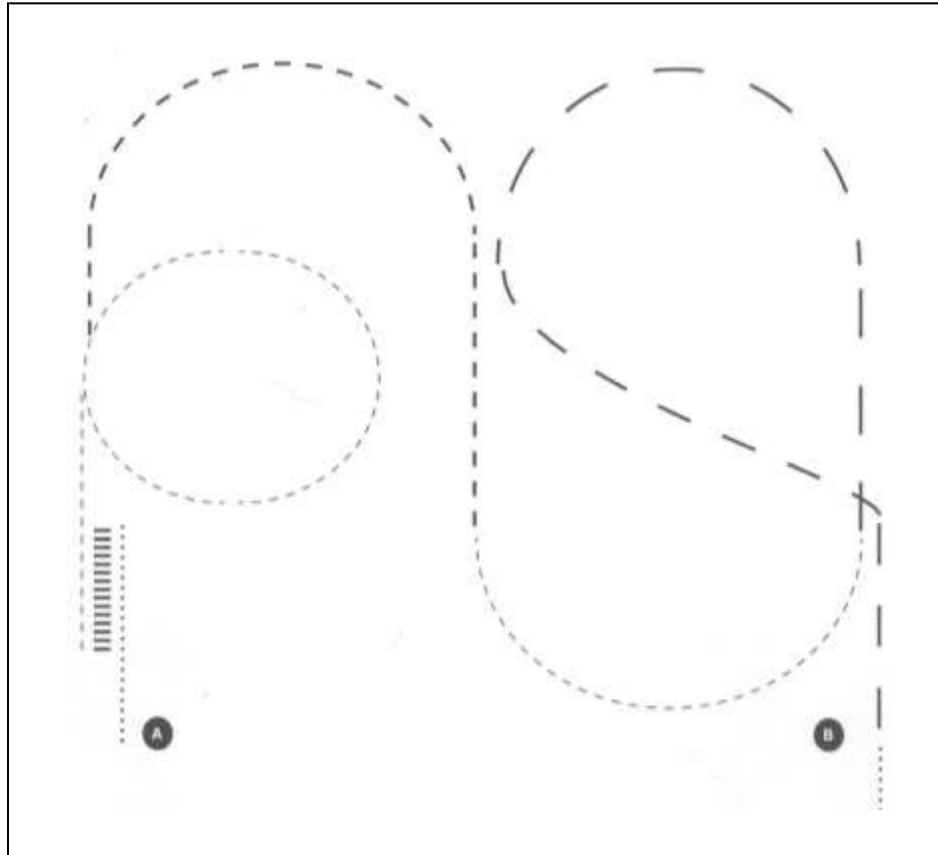

Reinsmanship Test 10

Test Elements: (10 points each)

1. At marker A, enter at the walk, walk several feet.
2. Halt, rein back 4 steps.
3. Collected trot circle to the right.
4. At the close of the circle, normal trot the first part of the loop.
5. Collected trot the second part of the loop to marker B.
6. At marker B, strong trot a loop ending back at marker B.
7. Walk to the exit.
8. Overall impression of the turnout on the condition and fit of the harness and vehicle, neatness of attire.
9. General impression of the driver on posture, relaxation, confidence, and effectiveness.

Perfect score = 90 points

REINSMANSHIP SCORING RUBRIC:

1. The entry receives numerical scores between 0 – 10 for:
 - A. Each Element – on use of aids, control of the horse(s), accuracy, quality of Transitions, and gaits (maximum total score = 10 x number of elements)
 - B. Overall Impression - of the turnout on the condition and fit of the harness and vehicle, neatness of attire. (maximum total score = 10)
 - C. General Impressions – of the driver on posture, relaxation, confidence, and effectiveness. (maximum total score = 10)
2. Perfect Score
 - + (10 points x total number of elements)
 - + 10 points for overall impression of turnout
 - + 10 points for general impression of driver
3. Reinsmanship ties are decided by the total of overall impression and general impression scores.
4. The scale of marks:

10 Excellent - 9 Very Good - 8 Good - 7 Fairly Good - 6 Satisfactory - 5 Marginal - 4 Insufficient - 3 Fairly Bad - 2 Bad - 1 Very Bad - 0 Not Executed*

*“Not executed” means that nothing of the required movement has been performed.

The judge may state the reason on the score sheet for each mark.
5. Penalties
 - A. Entries will be disqualified for:
 - a) Outside Assistance: If a groom or passenger touches the reins, whip or brake, or if the driver receives assistance from any source.
 - b) Failure to carry a whip in hand.
 - c) Failure to start the test within one minute of the signal to proceed or starting before the signal.
 - d) Being off pattern—not executing the test in the prescribed order and at the prescribed pace.

It is suggested that judge(s) post their score sheets following the completion of the class(es).

Pattern Class Score Sheets are available on the PtHA website.

Lead-line, 6 and under

General Regulations and Requirements

1. Equipment and attire may be either English or western but not a combination of both styles.
2. The person leading the horse must be at least 18 years old.
3. A lead shank will be attached to a halter that is under the bridle so that the person leading the mount could control the horse if necessary.
4. Participants in this class are not eligible to enter any other ISHSA equitation or performance classes at the show where they participated in lead-line, 6 and under.
5. This is NOT a placed class; however, all participants in this class will receive an award for their efforts.
6. Lead-line participants who show in five (5) or more shows will qualify for a year-end award.
7. No stallions allowed.

Position

1. The rider will be evaluated on his/her hand, leg, seat, and back position. In addition, the rider will be evaluated on his/her ability to hold the reins properly and cue the mount.

Class routine

1. Riders (and leaders) will enter the arena counterclockwise at the walk. Riders will be asked to walk in both directions of the arena. In addition, riders may be asked to back.
2. The leader should not aid the rider.

Class specifications:

See "*ISHSA Approved Class List*".

Class default rule book: For situations that are not covered by the ISHSA rule book, ISHSA will default to the PtHA rule book for English Equitation, western horsemanship, reinsmanship (driving equitation), and lead-line classes. To stay compliant with changes in the equine industry, ISHSA will add or subtract rules immediately following the lead of such changes made by the Pinto Horse Association. ISHSA will follow suit without needing to specifically vote on the changes.

It is suggested that judge(s) post their score sheets following the completion of the class(es).

Pattern Class Score Sheets are available on the AQHA website for English equitation and western horsemanship.

Blank Pattern Class Score Sheets are available on the PtHA website for reinsmanship equitation.

RULES FOR ENGLISH PLEASURE CLASSES

General

1. Points are accumulated by the horse and not by the exhibitor.

Hunter Seat Pleasure

2. General Regulations

- a. Horses shall be serviceably sound and shown without artificial appliances.
- b. Manes – It is recommended that entries be shown with natural or shortened mane and tail.
- c. Braids – Hunter style braiding; forelock and mane or forelock, mane and tail is optional in all classes. In hunt tradition, the tail is never braided unless the mane and forelock are also braided. The forelock is always braided when the mane is braided. The fact that an entry is or is not braided shall not be taken into consideration in the judging of a class, but entries braided in a non-conforming manner shall be penalized.
- d. Hunter Seat & Saddle Seat will be combined at ISHSA shows under the title of English Pleasure.

3. Appointments

- a. Saddle – Any acceptable Hunter Seat or forward seat saddle. Breastplates optional.
- b. Bridle – Snaffle, Pelham, Kimberwicke (single or double rein), or full bridle are permitted in all Hunter Seat classes. Full bridle must be ridden with double reins. Pelham (double rein curb type) must be ridden with double reins, unless bit converters are used to allow the use of a single rein. Copper wrapped and twisted wire bits are allowed, but must gauge a minimum diameter of 5/16 inch when measured one (1) inch in from cheek, and may have a port no higher than 1 ½”. On broken mouth pieces only, connecting rings of 1 1/4” or less in diameter or connecting flat bar of 3/8” - 3/4” measured top to bottom with a maximum length of two (2) inches which lie flat in the horse’s mouth are acceptable. Snaffle bit rings may be no larger than four (4) inches in diameter. Any bit having a fixed rein requires the use of a curb chain. Smooth round, oval or egg-shaped, slow twist, corkscrew, single twisted wire, double twisted wire mouthpieces and straight bar or solid mouthpieces are allowed. Any bit with sharp edges will be disqualified. A judge may, at his/her own discretion, penalize an entry with unconventional types of bits or nose bands in any class. In pleasure classes, a cavesson type nose band shall be used. Browband/cavessons other than hunter and dressage types not permitted. Saddle seat style colored browbands/cavessons and/or figure eight, drop, or flash nosebands are not permitted.
- c. No martingales or tie-downs permitted.
- d. Boots –Boots or bandages are prohibited. In the case of inclement weather, show management may permit the use of protective boots and/or bandages.

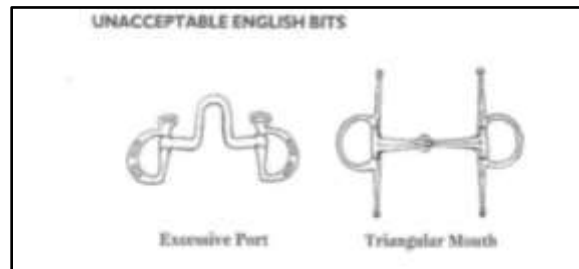
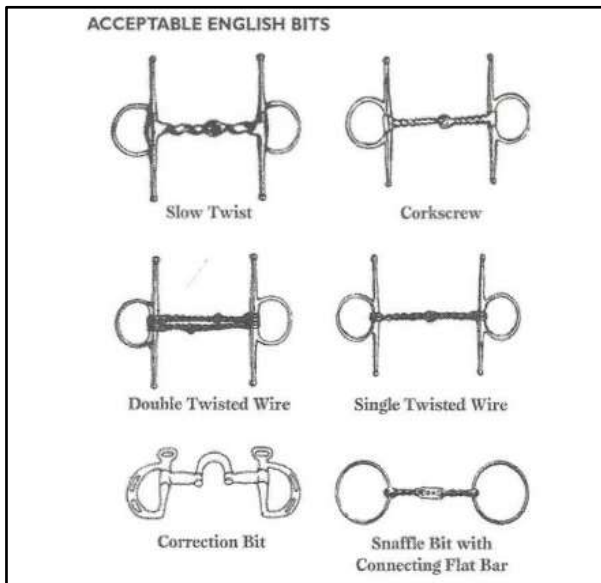

4. Attire

- a. Clothing – Exhibitors shall wear a traditional and conservative hunt coat (no reds, pinks, bright colors, etc.), suitable breeches (no black or white), hunt shirt with stock tie or choker, or oxford shirt with tie and helmet or hunt cap. Hunt bowler is also acceptable for adult exhibitors. Gloves are optional.
- b. Spurs are optional – if worn, must be of the unrowelled type that are blunt, round. No moveable parts.
- c. Crop or bat is optional – made with a stiff stock and up to thirty (30) inches in length, with no lash.
- d. It is optional for an exhibitor to wear a hard hat with harness in all classes.
- e. Judges, at their discretion, may authorize adjustments to attire due to weather-related conditions.

5. Judging

- a. Entries should give the appearance of being a pleasure to ride. To enter the ring at a trot if conditions permit.
- b. To be shown at a walk, trot and canter both ways of the ring. All gaits may be extended at the judge's discretion. A hand gallop may be required at the judge's discretion. Entries may be asked to back.
- c. Judges must consider all gaits equally in adjudicating this class.
- d. To be judged as pleasure horses on performance, manners, conformation, and suitability.

6. Gaits

- a. All gaits to be smooth, fluid, and efficient, without excessive knee action or short choppy strides. Faults would include: excessive movement on the forehead; behind the bit or over-collection; poll lower than withers; lazy, rushing, or inconsistent gaits. Any tendency to move in a western style jog, jog trot, or lope must be penalized.
 - i. Walk: free, ground-covering, four beat gait; rhythmic and flat-footed.
 - ii. Trot: true forward-moving two beat gait; cadenced and balanced; extreme speed to be penalized.

- iii. Canter: true forward moving three beat gait; smooth, balanced, and straight on both leads.
- b. Light contact with horse's mouth is required. Entries should be obedient, alert, responsive to move freely, and shall not be eliminated for slight errors.

Saddle Seat English Pleasure

1. Appointments

- a. Saddle – Flat English type (Cutback, Saddle seat) or park type saddle. Leather, web or suitable girth. Breastplate prohibited.
- b. Bridle – Light show type full Weymouth bridle (curb and snaffle bits), or double rein Pelham bridle. Single ring snaffle bit permitted for junior horses only. Twisted wire bits allowed only in the bradoon of a double bridle. Martingales prohibited for all horses.
- c. Boots or bandages are prohibited.

2. Attire

- a. Clothing – Informal attire consists of solid color saddle seat suit (day coats permitted) and derby or soft hat. Gloves are optional.
- b. Formal attire consists of dark-colored riding habit and accessories, or dark tuxedo-type jacket and jodhpurs to match, with top hat and gloves, or colored formal jacket with black jodhpurs, and derby or top hat and gloves.
- c. Spurs – of the unrowelled type that are blunt and round are optional.
- d. Whip – a slightly flexible whip, up to 72" in length including lash, is optional, with no appendage.

3. Judging

- a. Entries should give the appearance of being a pleasure to ride. To enter the ring at a trot if conditions permit.
- b. To be shown at a walk, trot, and canter, both ways of the ring. An extended trot and/or extended canter may be required. May be asked to back. Entries are required to walk prior to execution of change of gait.
- c. Judges must consider all gaits equally in adjudicating this class.
- d. To be judged as pleasure horse on performance, manners, conformation, suitability and appointments.
- e. Faults would include: stiff, rough, or choppy gaits; inconsistent rhythm and balance; above or behind the bit; poll not above withers; crooked or sideways movement. Any tendency to move in a western style must be penalized. When asked to extend a gait, the animal should remain in balance and lengthen his stride without quickening his tempo. Strong contact, over collection, excessive action, and excessive speed at any gait must be penalized.

4. Gaits

- a. Gaits to be smooth, balanced, collected, and consistent with conformation type of animal.
 - i. Walk: Regular, elastic, and ground covering four beat gait; engaging the hind legs.
 - ii. Trot: Balanced, free moving and elastic two beat gait, with somewhat collected balance.

- iii. Canter: Collected, smooth and straight on both leads, with three clean beats.
- b. Movement for all types except Saddle Type shall be medium or round, with forward reach and knee and hock flexion, but nothing in the extreme.
- c. Saddle Type movement shall be rounded and may display higher action, with more knee and hock flexion.

Gaited Horse English Pleasure

1. General Regulations

- a. Plantation shoes are not allowed. If the horse is shod, the shoe must be no wider than $\frac{3}{4}$ inch, no thicker than $\frac{3}{8}$ inch, with the exception of caulk that must be no thicker than $\frac{3}{4}$ inch, and the turn-back shall not exceed one inch. A single therapeutic pad may be worn with an accompanying veterinary certificate on file with the show management.
- b. Competitors enter the ring in a counterclockwise direction.
- c. Light contact must be maintained with all reins at all gaits.
- d. There should be a noticeable difference in the rate of speed between the first gait and the second gait, but a good second gait should never allow proper form to be sacrificed for excessive speed. (Note: Some horses travel faster than others in their gaits, so the term “excessive speed” should be interpreted as “out of control”, “deterioration of the second gait into pacing, or trotting”, and/or generally not performing the gait called for.)
- e. Horses are to be judged on manners, performance, suitability, quality, and conformation.
- f. The judge may call for a halt on the rail to test for quietness. Horses must stand quietly and back readily (if asked) with head in normal position and mouth closed.
- g. Saddle seat horses showing in a double bridle may not be asked to perform on only the snaffle or curb.
- h. All horses shall be worked at all gaits both directions of the ring following the class routine.
- i. No gimmicks, artificial appliances, or training devices are allowed to be used while in the show ring during the competition.
- j. Bandages or boots of any description for use on the horse are prohibited. Exceptions can be made for inclement weather or conditions. In the event of an injury, the judge may permit a protective bandage.
- k. Judge must severely penalize pumping of the reins in the canter.
- l. Excessive speed should be penalized. The pleasure horse should perform the breed specific gaits in a relaxed fashion with an alert and willing attitude. Any tendency to pace or trot should be penalized. The horse should display pleasure qualities necessary for road and trail riding, such as good manners, responsiveness, and manageability on a light rein, etc. The horse should stand quietly and back readily and straight.
- m. Hunter Seat & Saddle Seat will be combined at ISHSA shows under the title of English Pleasure—Gaited Horse.

2. Appointments

- a. Braids may be worn in English and halter classes, but are prohibited in western classes.
- b. Rhinestone or sequined browbands and cavesson fronts are allowed.
- c. Curb chains or straps must lie flat against the jaw and be at least ½ inch wide. Cross chain cavessons are prohibited.
- d. Martingales and tie downs are prohibited.
- e. Action devices and tail braces are prohibited.
- f. Whips, not to exceed four feet, are allowed in English pleasure.
- g. Snaffle bits are allowed in English pleasure classes. The entry will not be penalized for its use.
- h. Severe bits must be penalized in the final judging. Bits with shanks over nine and one-half inches (9 ½ inches) are prohibited. Only gag bits with shanks are allowed, example the wonder bit. Shanks are measured from the top of the metal to the very bottom of the metal; the rings are included in the measurement.
- i. Australian stock saddles are not approved as either English or western tack.

3. Saddle Seat

- a. The majority of gaited horses in this class utilize saddle seat English tack and attire. Snap-brim hat or derby or other proper saddle seat hat must be worn.
- b. Bridle shall be light, show type; either single curb, single snaffle, curb and snaffle, Pelham, or standard walking horse single rein bridle and bit. No martingales or tie-downs.
- c. English-type saddle (cutback). No forward seat (hunt seat) saddles allowed. Girth either leather, web, string or suitable material.
- d. Informal saddle seat attire is required, no hunt attire. Suggested are conservative colors such as black, blue, gray, beige or brown jacket with matching jodhpurs. Day coat with jodhpurs also permitted. Boots and derby or soft hat required. Contrasting hats, vests and/or ties are acceptable.
- e. Unrowelled spurs, whip or crop optional, at the exhibitor's discretion.

4. Hunt Seat

- a. A few breeds that participate in this class utilize hunt seat tack and attire.
- b. Bridle shall be light, show type; either snaffle, pelham, full bridle, kimberwick, or standard walking horse single rein bridle and bit is acceptable. Browband/cavessons other than hunter and dressage types not permitted. Saddle seat style colored browbands/cavessons and/or figure eight, drop, or flash nosebands are not permitted. No martingales or tie-downs permitted.
- c. Breastplate or breast collar is optional.
- d. Type of English saddle is optional, but forward seat type saddle recommended. No cutback saddles allowed. Girth either leather, web, string or suitable material.
- e. Informal attire of suitable material for hunting is required. It consists of conservatively colored coat of any tweed or Melton (conservative wash jackets in season), breeches (or jodhpurs), and boots. A conservatively colored hunting cap is mandatory. Formal attire is not permitted.
- f. Unrowelled spurs and crop or bat are optional at the exhibitor's discretion.

5. Qualifying gaits

- a. In order to accommodate several gaited horse breeds in the same class, the gait calls will be “First Gait”, “Second Gait”, “Canter”, and “Back”. Horses are to perform the gait as per their breed standards. Because different gaited breeds perform different gaits, judges may feel free to ask each exhibitor the breed of his or her horse before the start of a class if it would make adjudicating the class easier.
- b. First Gait: to be performed at a speed similar to a trot, not to be confused with a dog-walk.
 - i. Flat Walk – performed by the Tennessee Walker, Missouri Fox Trotter, and Paso Fino – is a 4 beat (1-2-3-4) gait with each of the horse’s feet hitting the ground separately at regular intervals. A true flat walk is a lateral four-beat gait in which each foot is picked up and set down in an even cadence. Additionally, the Tennessee Walker is to glide over the track of the front foot with the hind foot (over stride). The horse will nod the head in rhythm with the cadence of its feet. This head nod is desirable. The Missouri Fox Trotter is not a high stepping horse. The rear end movement should be smooth and close to the ground without any snap or pop. Each stride should reach forward and slide in as it is set down, over striding the track of the front foot. The head and tail are slightly elevated, giving the animal a graceful carriage; the rhythmic beat of the hooves, along with the nodding action of the head, give the animal an appearance of relaxation and poise.
 - ii. Paso Llano—performed by the Peruvian Paso—is an evenly spaced 4 beat (1-2-3-4) gait – left hind, left front, right hind, right front.
 - iii. Pleasure Walk—performed by the Racking Horse—is a true 4 beat walk in which rider and horse are at complete ease.
 - iv. Show Gait—performed by the United Mountain Horse—is a collected 4 beat gait performed at moderate speed. It is collected and smooth.
 - v. Show Walk—performed by the Spotted Saddle Horse—is a smooth easy gait. The backend is smooth and the horse is under control. It is an easy comfortable ride. Headshake is acceptable.
- c. Second Gait: to be performed at a speed similar to that of an extended trot.
 - i. Running Walk—performed by the Tennessee Walker—is a brisk 4 beat even lateral gait. Horses will glide over the track left by the front foot with the hind foot and will nod its head in time with the cadence of its feet. It is executed with more speed than the flat walk without sacrificing correct form. Head nod, timing, and consistency are to be considered. Form should not be sacrificed for speed.
 - ii. Fox Trot – performed by the Missouri Fox Trotter – is basically a diagonal gait. The horse will perform this gait by walking in front and trotting behind with reach in each stride. The horse may disfigure or overstep his track provided the horse travels straight on all four legs. The fox trot will be performed in a stylish manner. The back feet must exhibit a sliding action in order to keep the beat of the gait. The horse

will carry its head slightly elevated, having as much rhythmic head motion as possible. This head motion should always be in time with the movement of the feet.

- iii. Paso Corto—performed by the Paso Fino—is a smooth, steady, unbroken, evenly spaced 4 beat lateral gait. It is rhythmic, executed with moderate extension and mild collection. The headset is to be natural and relaxed.
 - iv. Sobreando—performed by the Peruvian Paso—is faster and slightly more lateral than the Paso Llano. The footfall is 1-2-3-4, left hind-left front – right hind-right front.
 - v. Slow Rack—performed by the Racking Horse—is a 4 beat, evenly timed lateral gait, 1-2-3-4. It is similar to the Running Walk with the distinction in stride length and timing. The rack does not have quite the over-stride of the running walk and the footfalls are extremely rapid with more knee action.
 - vi. Mountain Pleasure Gait—performed by the United Mountain Horse—is a 4-beat gait executed with more speed, stride, and action than the show gait.
 - vii. Show Gait—performed by the Spotted Saddle Horse—is an increase in speed from the Show Walk with the horse still under control and the head set.
- d. Canter: a true three-beat or four-beat gait: smooth, slow, easy and straight on both leads.
- e. Unacceptable Gaits:
- i. The trot and the pace are not acceptable gaits in the Gaited Horse classes. They are to be heavily penalized.
 - ii. Trot: a two-beat diagonal gait: straight and regular. 1-2, left hind-right front, right hind-left front.
 - iii. Pace: a two-beat lateral gait with fore and hind legs on the same side moving and landing together. 1-2, left hind-left front, right hind-right front.
- f. Class routine:
- Horses shall enter the ring at the dog walk and when the gate is closed, the judge shall call for gaits in the following order for the 3-gait class. The 2-gait class will follow the same procedure but without the canter.
- i. first gait,
 - ii. second gait,
 - iii. first gait
 - iv. canter
 - v. first gait and reverse direction at the first gait,
 - vi. second gait,
 - vii. first gait
 - viii. canter
 - ix. first gait and line up
 - x. back (Back is required. It may be called for on the rail during the class or may be called for in the final line up.)

English Disciplined Rail

1. General

- a. This class is to show the ability of a highly trained horse.
- b. Appointments shall follow those of English pleasure classes.
- c. Judge shall work the horses adequately but must not overwork the entries. This is not a game or a fault and out class, and shall not be judged on an elimination basis. Final judging shall be on the basis of the best overall disciplined rail performance. At all times, the safety of the horses and exhibitors to be the first concern.
- d. Entries may be shown in either hunter seat or saddle seat tack or apparel.

2. Class Routine

- a. Entries shall be asked to perform work on the rail, and may include, but is not limited to:
 - i. A short walk, trot, extended trot, or canter. (Gaited horses—1st gait, 2nd gait)
 - ii. A hand gallop
 - iii. Simple changes of lead each way of the ring
 - iv. Starting into a canter from a halt.
 - v. Square stop.
 - vi. Starting and traveling on the counter canter.
 - vii. Leg-yield both left and right on the rail and/or on the diagonal once each way.
 - viii. Turn on forehand and/or haunches, once each way.
 - ix. Shoulder-in and/or haunches-in and/or out at a walk and/or trot, once each way for each movement.
 - x. Stand quietly.
 - xi. Working of entrants “on the buckles” or without contact of the reins is limited to the walk only. Any other movements will not be asked to be performed except with light contact. Riding “on the buckles” will not be considered riding with light contact.
 - xii. For safety reasons, exhibitors will not be required to mount or dismount as part of the class routine, with the exception of equipment checks.
 - xiii. Judge may ask for additional safe work.
- b. To be judged on performance, manners and conformation.

Class specifications:

See “*ISHSA Approved Class List*”.

Class default rule book: For situations that are not covered by the ISHSA rule book, ISHSA will default to the PtHA rule book for English pleasure classes.

RULES FOR WESTERN PLEASURE CLASSES

General

1. Points are accumulated by the horse and not by the exhibitor.
2. Entries shall be serviceably sound and shown without artificial appliances.
3. Any horse showing evidence of altered tail carriage may be penalized.
4. If bridles are to be removed for bit checks, riders must be dismounted. It is the responsibility of the judge to check bits.
5. Split Reins
 - a. One hand is to be used on the reins and the hand must not be changed.
 - b. The hand is to be around the reins.
 - c. Index finger only between split reins is permitted.
 - d. The tails of the reins must be crossed on the opposite side of the neck when riding with two hands on split reins, except in reining.
 - e. Closed reins, (example mecate) may not be used with a snaffle bit except in reining, where a mecate, which may include a tie rein, is permitted.
 - f. In trail, it is permissible to change hands to work an obstacle.
 - g. Exception to the rule will be the following classes:
 - i. Hackamore/snaffle bit classes
 - ii. Junior horses shown with hackamore/snaffle bit
 - iii. Violation of this rule is an automatic disqualification.
6. Romal Reins
 - a. Romal is defined as an extension of braided material attached to closed reins.
 - b. This extension shall be carried in the free hand with a minimum of sixteen (16) inch spacing between the reining hand and the free hand holding the romal.
 - i. When using romal reins, the rider's hand shall be around the reins with the wrists kept straight and relaxed, the thumb on top and the fingers closed lightly around the reins.
 - ii. When using a romal, no fingers between the reins are allowed.
 - iii. The free hand may be used to adjust the rider's length of rein in any class except in reining where the free hand may not be used to adjust the rider's length of rein.
 - iv. The romal shall not be used forward of the cinch or to signal or cue the horse in any way. Any infraction of this rule shall be penalized severely by the Judge.
 - v. Use of romal other than as outlined will result in disqualification.
7. Junior Horses
 - a. Junior horses shown with a hackamore or snaffle bit must be ridden with two (2) hands.
 - b. A junior horse previously exhibited in a curb bit may return to a bosal or snaffle in another class.
8. Spurs used forward of the front cinch shall be cause for disqualification.
9. For safety reasons, an exhibitor will not be disqualified for holding the saddle horn but penalized at the judge's discretion or unless class rules otherwise specified.
10. Western Attire

- a. Any tack and/or attire infraction is to be considered as a penalty, not a disqualification, unless specific class rules require a disqualification.
- b. Chaps, shotgun chaps, or chinks are optional unless prohibited by specific class rules.
- c. Ties and/or scarfs are optional.
- d. Jeans are appropriate attire.
- e. In Stock Type halter and other western classes, appropriate western attire is required which includes western hat, long-sleeved shirt with collar (band, standup, tuxedo etc.), jeans, slacks or pants, and western boots. Gloves and spurs are optional. No spurs are allowed in in-hand, halter, or showmanship classes.
 - i. It is optional that an exhibitor may wear a hard hat with harness in all classes. The hat must be on the rider's head when the exhibitor enters the arena.
 - ii. Gloves and spurs are optional. (Exception spurs are not permitted in in-hand, halter, or showmanship classes.)
 - iii. Riding length (below the knee) skirts are acceptable attire in all halter classes, if in good taste.
 - iv. Judges, at their discretion, may authorize adjustments to attire due to weather-related conditions.
- f. Western Appointments
 - i. Saddle – Entries shall be shown with a stock saddle with a horn, but silver equipment will not count over a good working outfit. Tapaderos are prohibited unless otherwise noted.
 - ii. The carrying of a lariat or riata, attached to fork of saddle is optional.
 - iii. Bit/Bridle - There shall be no discrimination against any standard bridle or standard western bit. A standard western curb bit is defined as having a shank with a maximum length overall of 8-1/2 inches.
 - iv. The mouthpiece of a curb bit will consist of a smooth metal bar with a minimum diameter of 5/16 inch. The port of a curb bit may be no higher than three and a half inches (3 1/2") from the bottom of the bar to the top of the port.
 - v. Rollers contained within a legal port are acceptable. The actual roller may extend below the level of the bar. Nothing may be connected or protruding below the bar.
 - vi. Any curb bit with sharp edges will be disqualified.
 - vii. Wire on bits, bosals, or curb chains are prohibited.
 - viii. Roping bits with both reins connected to a single ring at the center of the cross bar are prohibited.
 - ix. One rein must be attached to each shank.
 - x. The judge may prohibit the use of any equipment he/she considers severe or inhumane.
 - xi. Curb chains may be used, but must be at least 1/2" inch in width and lie flat against the jaw.
 - xii. Horses shall not be shown with artificial appliances that would tend to alter its performance.

- xiii. No wire or other metal or rawhide may be used in conjunction with, or as part of, the flat leather chin strap, which must be at least ½ inch in width. Round rolled, braided, or rawhide curb straps are prohibited.
- xiv. Hackamore bits, mechanical hackamore, cavesson-type nosebands, martingales, tie-downs, and choke ropes are prohibited.
- xv. Boots or bandages are prohibited in western pleasure and trail classes. The use of shin and/or bell boots on the front legs and standard sliding or rundown boots on rear fetlocks is optional in individual working classes (reining) unless otherwise noted. In the event of injury, the judge may permit a protective bandage.
- xvi. Junior horses, five (5) years and under, may be shown in a standard rawhide or leather braided hackamore (consisting of flexible bosal, headstall, and reins) or ring snaffle in any class. Bosal must be a maximum of ¾ inch in diameter. No iron is permitted under the jaw regardless of how padded or taped on the bosal portion of the hackamore. In no case does this refer to a so-called “mechanical hackamore” which is prohibited. Absolutely no metal under the jaw or as part of the noseband is permitted in conjunction with the bosal. A complete mecate rein, which includes a tie-rein is optional with a bosal.
- xvii. A judge does not have the authority to add to or remove any of the standard equipment as specified.

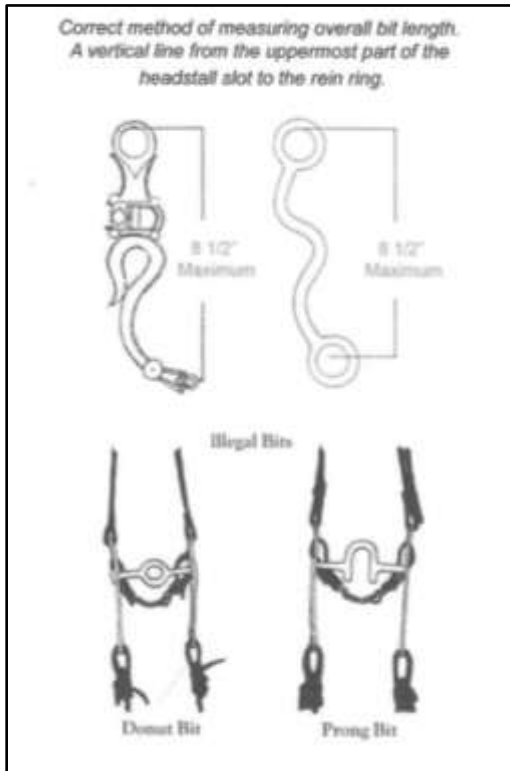

- g. Western Gaits
 - i. In western pleasure, trail, western riding, western disciplined rail classes, all gaits should be smooth, relaxed, easy, and efficient.
 - ii. Stock and Hunter Types will move with low strides, poll no lower than level with withers, with little flexion at the knees and hocks.
 - iii. Pleasure types will move with rounded, medium strides, flexed neck with poll higher than withers, and will display forward reach and flexion of the knees and hocks.
 - iv. Saddle types will move with more energy and a higher head carriage with marked flexion of the knees and hocks. In all cases, the animal should appear balanced and engage its hind legs.
 - v. The horse should move out willingly while remaining balanced and able to stop and stand quietly.
 - vi. Faults would include rough gaits; excessive speed (taking into consideration the difference between types); working excessively on the forehand; inconsistent rhythm and breaking up the clean rhythm of the gait (shuffling or walking with back feet in the jog or four-beat lope).
 - vii. Description
 - 1. Walk: Free moving but unhurried four beat gait; rhythmical and flat-footed.
 - 2. Jog: Smooth, ground covering two beat gait, with a relaxed back, suspension, and rate that is normal for the conformation type of the entry.
 - 3. Lope: Rhythmical, smooth, unconstrained, with rate that is normal for the conformation type of the entry; elastic and balanced, with three clean beats.
 - 4. Extended gaits: Noticeable difference between the regular and extended gait; no loss of form or balance; excessive speed in any extended gait must be penalized; extensions are accomplished with a lengthening of stride and not just increased speed. All gaits may be extended.
- h. Equipment for horses using snaffles or bosals in any class.
 - i. Entries are to be shown in standard, plain, or silver head stalls with brow band, shaped ear, or split ear. Smooth snaffle bit with broken mouth-piece of conventional O-ring, egg butt, or D-ring style with ring no larger than four (4) inches and no smaller than two (2) inches. Snaffle bit to be measured, one inch (1) in from cheek, and must be a minimum of 5/16 inch in diameter with a gradual decrease to the center of the snaffle. Optional loose curb strap, of leather or nylon only. Mouthpiece may be inlaid, but must be smooth, or rubber latex wrapped. No twisted wire snaffle bits allowed. No twists or rolls in snaffle bit mouthpiece are allowed.
 - ii. Reins are to be attached above the curb strap.
 - iii. Standard, leather or woven, split reins are mandatory with a snaffle bit. Closed reins (example mecate) may not be used with a snaffle bit except in reining.

- iv. The tails of the reins must be crossed on the opposite side of the neck when riding with two hands on split reins. The exhibitor's hands should be carried by the pommel and the reins bridged, so both reins are in each hand.
- v. Martingales, nose bands, or tie downs are prohibited.
- vi. A flexible braided rawhide or leather bosal may be used in lieu of a snaffle bit, no larger than $\frac{3}{4}$ inch diameter at the cheek; must be a minimum of a one-finger space, approximately $\frac{3}{4}$ inch, between the bosal and nose; absolutely no metal under the jaw or in the noseband in connection with the bosal. The bosal should be properly fitted relative to size and conformation of the horse. A complete Mecate rein, which includes a tie-rein, is optional with a bosal.

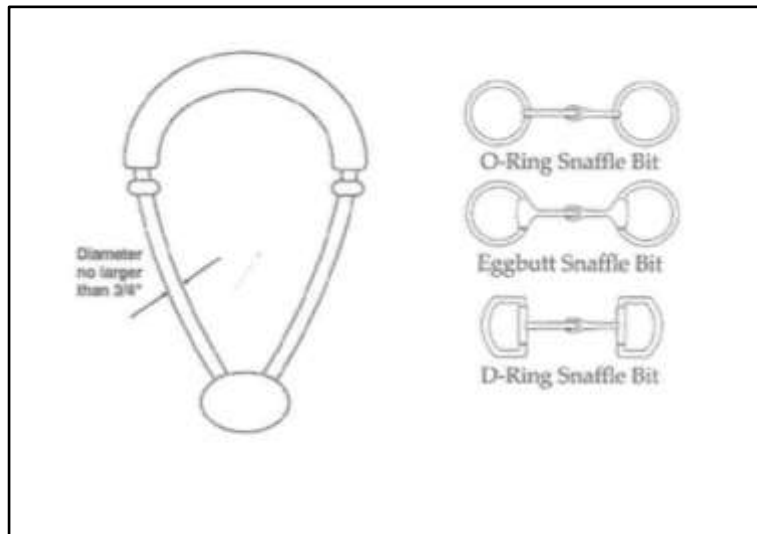

11. Western Pleasure

a. General

- i. Horse to be judged on performance, manners, conformation, suitability and appointments.
- ii. The western pleasure horse should be a pleasure to ride and a free, natural mover.

b. Gaits

- i. Entries to be shown at a walk, jog, and lope, both ways of the ring, on a reasonably loose rein, without undue restraint.
- ii. Judge may ask for an extension at any gait.
- iii. Judges must consider all gaits equally in adjudicating this class.
- iv. All entries being considered for an award may be asked to back in a straight line.
- v. If a horse is traveling properly in all three gaits, it should not be penalized for passing another entry.

c. Judging

- i. The ideal western pleasure entry should carry its head in a position that is normal for its type and no lower than level.

- ii. Reasonably loose reins, with light contact, should be maintained at all times.
 - iii. All horses chosen for a workout must be worked both ways of the ring, at any gait requested by the judge.
 - iv. Draft breeds regardless of age may be shown in a snaffle in any western style class except senior horse where a standard western curb bit is required.
 - v. Beginning western horses 1st year and green western horses 1st or 2nd year regardless of age may be shown in a snaffle in any western style class except senior horse where a standard western curb bit is required.
- d. Faults
- i. Carrying the head in such a position that the point of the poll is lower than the withers or being flexed behind the vertical are to be considered major faults.
 - ii. Horses that are considered by the judge as appearing lethargic, sullen, drawn, emaciated, or overly tired should not be considered for a placing.

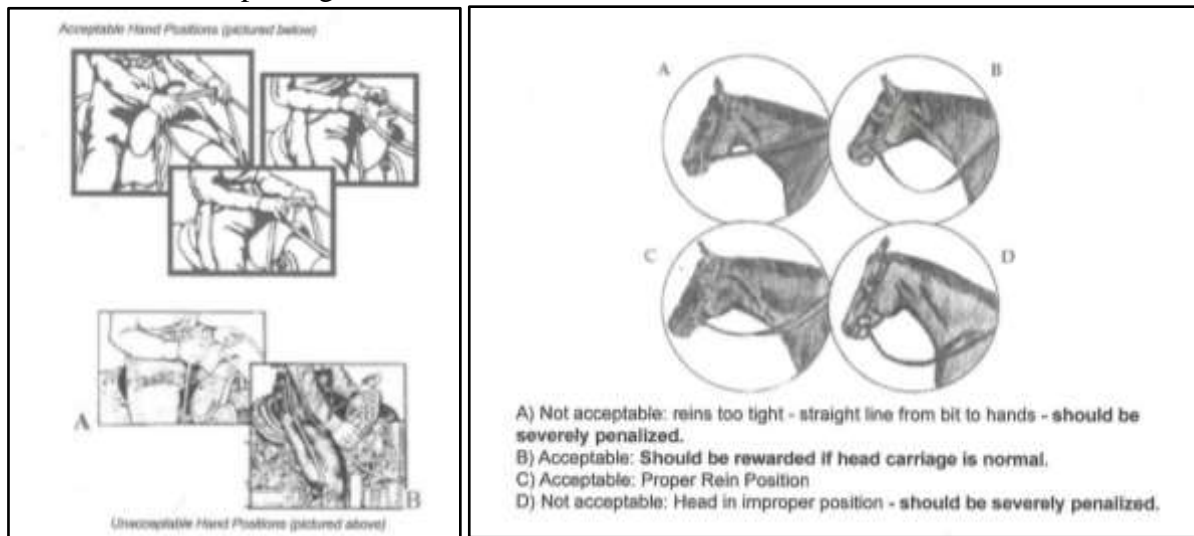

Gaited Horse Western Pleasure

1. General

- a. Plantation shoes are not allowed. If the horse is shod, the shoe must be no wider than $\frac{3}{4}$ inch, no thicker than $\frac{3}{8}$ inch, with the exception of caulk that must be no thicker than $\frac{3}{4}$ inch, and the turn-back shall not exceed one inch. A single therapeutic pad may be worn with an accompanying veterinary certificate on file with the show management.
- b. Entry shall reflect suitability of the gaited horse as a western working horse, exhibiting qualities suitable for ranch work. The western pleasure horse works quietly exhibiting an exceptionally smooth, comfortable ride without excessive action or animation.
- c. Competitors enter the ring in a counterclockwise direction.
- d. Light contact with the horse's mouth must be maintained at all gaits.
- e. There should be a noticeable difference in the rate of speed between the first gait and the second gait, but a good second gait should never allow proper

form to be sacrificed for excessive speed. (Note: Some horses travel faster than others in their gaits, so the term “excessive speed” should be interpreted as “out of control”, “deterioration of the second gait into pacing, or trotting”, and/or generally not performing the gait called for.)

- f. If bridles are to be checked, it is the sole decision of the judge to do so. Riders must dismount.
 - g. All horses will be worked at all gaits both directions of the ring following the class routine.
 - h. Boots and/or bandages are not permitted. Exceptions can be made for inclement weather or conditions. In the event of an injury, the judge may permit a protective bandage.
 - i. Horses shall not be shown with artificial appliances that would tend to alter their performance.
 - j. While the horse is in motion, the rider’s hands shall be clear of horse and saddle.
 - k. The judge may call for a halt on the rail to test for quietness. Horses must stand quietly and back readily (if asked) with head in normal position and mouth closed.
 - l. When a bit with a shank is used, only one hand may be used on reins and hands must not be changed. Hand to be around reins. When end of split reins falls on side of reining hand, one finger between reins is permitted. When using romal or when ends of split reins are held in hand not used for reining, no finger between reins is allowed. Rider may hold romal or end of split reins to keep them from swinging and to adjust the position of the reins provided it is held at least 16 inches from the reining hand. When a bosal or standard snaffle is used, two (2) hands may be used.
 - m. Horses are to be judged on manners, performance of gaits, suitability, quality, and conformation.
2. Appointments:
- a. Competitors must be penalized for incomplete appointments, but not necessarily disqualified.
 - b. Reins must be attached to each shank of the bit.
 - c. Roping bits with both reins connected to a single ring at center of cross bar shall not be used.
 - d. Any rein design or other device which increases the effective length and thereby the leverage of the shank of the bit is prohibited.
 - e. Hackamore bits, cavesson type nosebands especially cross chain cavessons, martingales, and tie-downs are prohibited.
 - f. Braids may be worn in English and halter classes, but are prohibited in western classes.
 - g. Curb chains or straps must lie flat against the jaw and be at least ½ inch wide.
 - h. Action devices and tail braces, and whips of any kind are prohibited.
 - i. Severe bits must be penalized in the final judging. Bits with shanks over nine and one-half inches (9 ½ inches) are prohibited. Only gag bits with shanks are allowed, example the wonder bit. Shanks are measured from the top of the metal to the very bottom of the metal; the rings are included in the measurement.

- j. Junior horses, those five years old and under, may be shown in a standard snaffle bit or bosal.
 - k. Any standard stock saddle with a horn is permissible, but silver equipment will not count over a good working outfit.
 - l. Australian stock saddles are not approved as either English or western tack.
 - m. The horse will wear a western bridle with no cavesson and bit with shanks not to exceed 9 ½ inches.
 - n. Riders shall wear western hat, long-sleeved shirt with any type collar, trousers or pants (one-piece long-sleeved equitation suit is acceptable provided it includes a collar), and western boots. A vest, jacket, coat, and/or sweater may also be worn. Protective headgear may be worn without penalty.
 - o. Rope, riata and/or hobbles are optional.
 - p. Chaps or chinks are optional.
 - q. Spurs are optional.
3. Qualifying gaits
- a. In order to accommodate several gaited horse breeds in the same class, the gait calls will be “First Gait”, “Second Gait”, “Lope”, and “Back”. Horses are to perform the gait as per their breed standards. Because different gaited breeds perform different gaits, judges may feel free to ask each exhibitor the breed of his or her horse before the start of a class if it would make adjudicating the class easier.
 - b. First Gait: to be performed at a speed similar to a trot, not to be confused with a dog walk.
 - i. Flat Walk – performed by the Tennessee Walker, Missouri Fox Trotter, and Paso Fino – is a 4 beat (1-2-3-4) gait with each of the horse’s feet hitting the ground separately at regular intervals. A true flat walk is a lateral four-beat gait in which each foot is picked up and set down in an even cadence. Additionally, the Tennessee Walker is to glide over the track of the front foot with the hind foot (over stride). The horse will nod the head in rhythm with the cadence of its feet. This head nod is desirable. The Missouri Fox Trotter is not a high stepping horse. The rear end movement should be smooth and close to the ground without any snap or pop. Each stride should reach forward and slide in as it is set down, over striding the track of the front foot. The head and tail are slightly elevated, giving the animal a graceful carriage; the rhythmic beat of the hooves, along with the nodding action of the head, give the animal an appearance of relaxation and poise.
 - ii. Paso Llano—performed by the Peruvian Paso—is an evenly spaced 4 beat (1-2-3-4) gait – left hind, left front, right hind, right front.
 - iii. Pleasure Walk—performed by the Racking Horse—is a true 4 beat walk in which rider and horse are at complete ease.
 - iv. Show Gait—performed by the United Mountain Horse—is a collected 4 beat gait performed at moderate speed. It is collected and smooth.

- v. Show Walk—performed by the Spotted Saddle Horse—is a smooth easy gait. The backend is smooth and the horse is under control. It is an easy comfortable ride. Headshake is acceptable.
- c. Second Gait: to be performed at a speed similar to that of an extended trot.
 - i. Running Walk—performed by the Tennessee Walker—is a brisk 4 beat even lateral gait. Horses will glide over the track left by the front foot with the hind foot and will nod its head in time with the cadence of its feet. It is executed with more speed than the flat walk without sacrificing correct form. Head nod, timing, and consistency are to be considered. Form should not be sacrificed for speed.
 - ii. Fox Trot – performed by the Missouri Fox Trotter – is basically a diagonal gait. The horse will perform this gait by walking in front and trotting behind with reach in each stride. The horse may disfigure or overstep his track provided the horse travels straight on all four legs. The fox trot will be performed in a stylish manner. The back feet must exhibit a sliding action in order to keep the beat of the gait. The horse will carry its head slightly elevated, having as much rhythmic head motion as possible. This head motion should always be in time with the movement of the feet.
 - iii. Paso Corto—performed by the Paso Fino—is a smooth, steady, unbroken, evenly spaced 4 beat lateral gait. It is rhythmic, executed with moderate extension and mild collection. The headset is to be natural and relaxed.
 - iv. Sobreando—performed by the Peruvian Paso—is faster and slightly more lateral than the Paso Llano. The footfall is 1-2-3-4, left hind-left front – right hind-right front.
 - v. Slow Rack—performed by the Racking Horse—is a 4 beat, evenly timed lateral gait, 1-2-3-4. It is similar to the Running Walk with the distinction in stride length and timing. The rack does not have quite the over-stride of the running walk and the footfalls are extremely rapid with more knee action.
 - vi. Mountain Pleasure Gait—performed by the United Mountain Horse—is a 4 beat gait executed with more speed, stride, and action than the show gait.
 - vii. Show Gait—performed by the Spotted Saddle Horse—is an increase in speed from the Show Walk with the horse still under control and the head set.
- d. Lope: a true three-beat or four-beat gait: smooth, slow, easy and straight on both leads.
- e. Unacceptable Gaits
 - i. The trot and the pace are not acceptable gaits in the Gaited Horse classes. They are to be heavily penalized.
 - ii. Trot: a two-beat diagonal gait: straight and regular. 1-2, left hind-right front, right hind-left front.
 - iii. Pace: a two-beat lateral gait with fore and hind legs on the same side moving and landing together. 1-2, left hind-left front, right hind-right front.

- f. Class routine:
Horses shall enter the ring at the dog walk and when the gate is closed, the judge shall call for gaits in the following order for the 3-gait class. The 2-gait class will follow the same procedure but without the lope.
- i. first gait,
 - ii. second gait,
 - iii. first gait,
 - iv. lope,
 - v. first gait and reverse direction at the first gait,
 - vi. second gait,
 - vii. first gait,
 - viii. lope,
 - ix. first gait and line up
 - x. back (Judges may ask entries to back. The back may be called for on the rail during the class or may be called for in the final line up.)

Western Disciplined Rail

General

1. This class is to show the ability of a highly trained western horse. Appointments shall follow those of western pleasure classes.
2. Judge shall work the horses adequately, but must not overwork the entries. This is not a game or a fault and out class, and shall not be judged on an elimination basis. Final judging shall be on the basis of the best overall disciplined rail performance. At all times, the safety of the horses and exhibitors to be the first concern.
3. Western disciplined rail classes must be restricted to western equipment.
4. The class routine shall be to perform work on the rail, and may include, but is not limited to:
 - a. A short walk, jog, extended jog, or slow lope. (Gaited horses—1st gait, 2nd gait)
 - b. A hand gallop.
 - c. Flying changes of lead each way of the ring.
 - d. Starting into a lope from a halt.
 - e. Sliding stop.
 - f. Starting and traveling on the counter lope
 - g. Side pass both left and right (once each way).
 - h. Turn on forehand and turn on hind quarter (once each way).
 - i. For safety reasons, exhibitors will not be required to mount or dismount as part of the class routine, with the exception of equipment checks.
 - j. Stand quietly.
 - k. Judge may ask for additional safe work.
5. To be judged on performance, manners and conformation.

Class specifications:

See “*ISHSA Approved Class List*”.

Class default rule book: For situations that are not covered by the ISHSA rule book, ISHSA will default to the PtHA rule book for western pleasure classes.

RULES FOR WESTERN RIDING CLASSES

General:

1. Points are accumulated by the horse and not by the exhibitor.
2. The horse is judged on quality of gaits, lead changes at the lope, response to the rider, manners and disposition. The horse should perform with reasonable speed, and be sensible, well-mannered, free and easy moving. Credit shall be given for and emphasis placed on smoothness, even cadence of gaits (i.e., starting and finishing pattern with the same cadence), and the horse's ability to change leads precisely, easily and simultaneously both hind and front at the center point between markers. In order to have balance, with quality lead changes, the horse's head and neck should be in a relaxed, natural position, with his poll level with or slightly above the level of the withers. He should not carry his head behind the vertical, giving the appearance of intimidation, or be excessively nosed out, giving a resistant appearance. The horse should have a relaxed head carriage showing response to the rider's hands, with a moderate flexion at the poll. Horses may be ridden with light contact or on a reasonably loose rein. The horse should cross the log both at the jog (1st gait) and the lope without breaking gait or radically changing stride.
3. The judge will select one of the eight patterns to be performed. The judge is responsible for the pattern being correctly set.
4. On the patterns (*Refer to diagrams below*):
 - A. The small circles represent pylon markers which are recommended. These should be separated by a uniform measured distance of not less than 30 feet nor more than 50 feet on the sides with 5 markers (see diagram). In Pattern 1, the three markers on the opposite side should be set adjacent to the appropriate markers. It is recommended that markers be set a minimum of 15 feet from the fence and with 50 to 80 foot width in the pattern, as the arena permits.
 - B. A solid log or pole should be used and be a minimum of 8 feet in length.
 - C. The long serpentine line indicates the direction of travel and gaits at which the horse is to move. The shaded area represents the lead changing area between the markers. The dotted line (...) indicates walk, the dash line (- - -) jog or 1st gait, and the solid line (-) lope.
 - D. A cone shall be placed along the wall or rail of the arena to designate where the exhibitor should initiate the walk. On western riding patterns 1, 3, 5 and Level 1 pattern 1, the start cone should be placed a minimum of 15 feet before the first pattern maker. On western riding patterns 2, 4 and Level 1 Patterns 2 and 4, the start cone should be placed even with the first pattern marker. The on-deck exhibitor should not go to the start-cone until the contestant on pattern has cleared the working area by the start-cone for the final time.
5. Pattern should be posted a minimum of one (1) hour prior to the start of the class.

Appointments:

Refer to "*Rules for Western Pleasure*" Protective leg wear on the horse is optional.

WESTERN RIDING PATTERN I

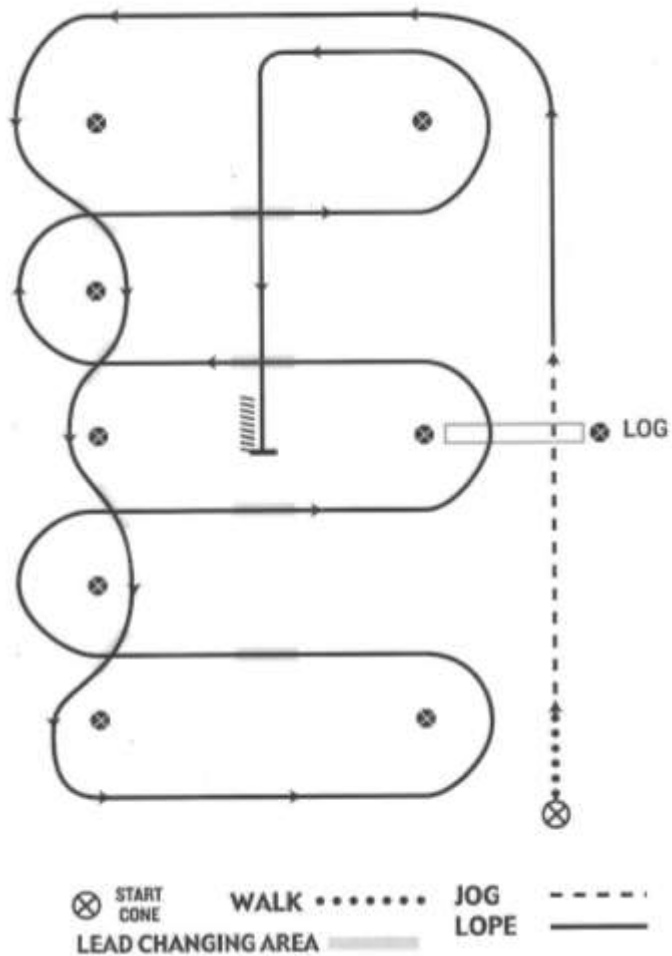

1. Walk at least 15 feet from the start cone to the first marker, transition to jog or 1st gait, jog or 1st gait over log
2. Transition to left lead & lope around the end of arena
3. First line change
4. Second line change
5. Third line change
6. Fourth line change and lope around the end of arena
7. First crossing change
8. Second crossing change
9. Lope over log
10. Third crossing change
11. Fourth crossing change
12. Lope up the center, stop and back

WESTERN RIDING PATTERN 2

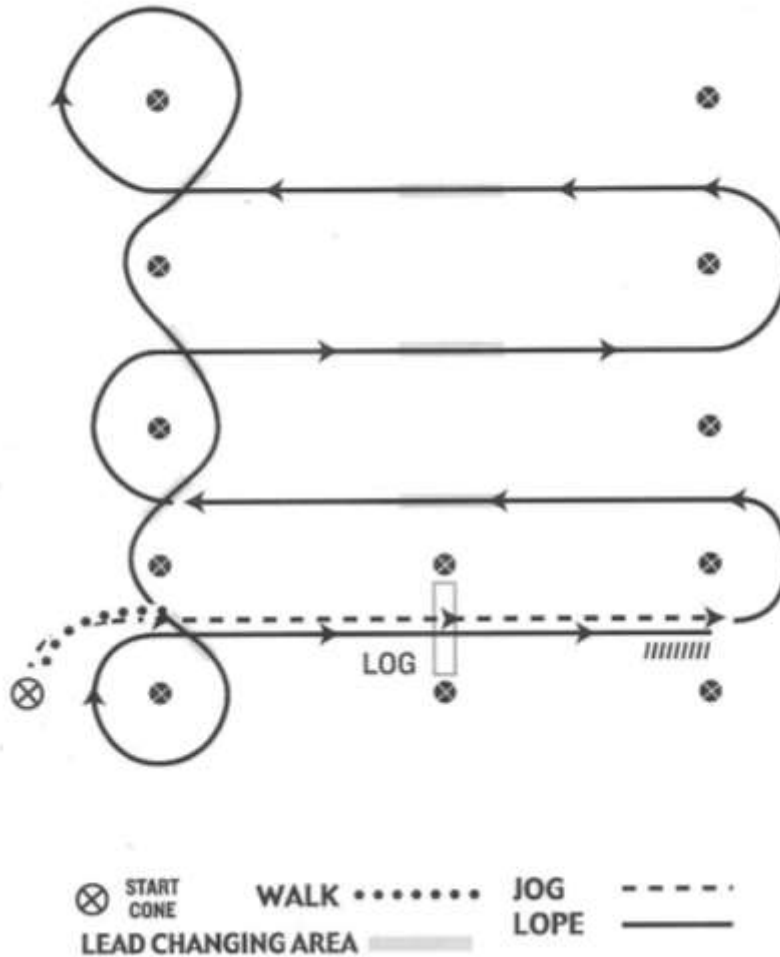

1. Walk at least 15 feet from start cone to the first marker, transition to jog or 1st gait, jog or 1st gait over log
2. Transition to the lope, on the left lead
3. First crossing change
4. Second crossing change
5. Third crossing change
6. Circle and first line change
7. Second line change
8. Third line change
9. Fourth line change and circle
10. Lope over log
11. Lope, stop, and back

WESTERN RIDING PATTERN 3

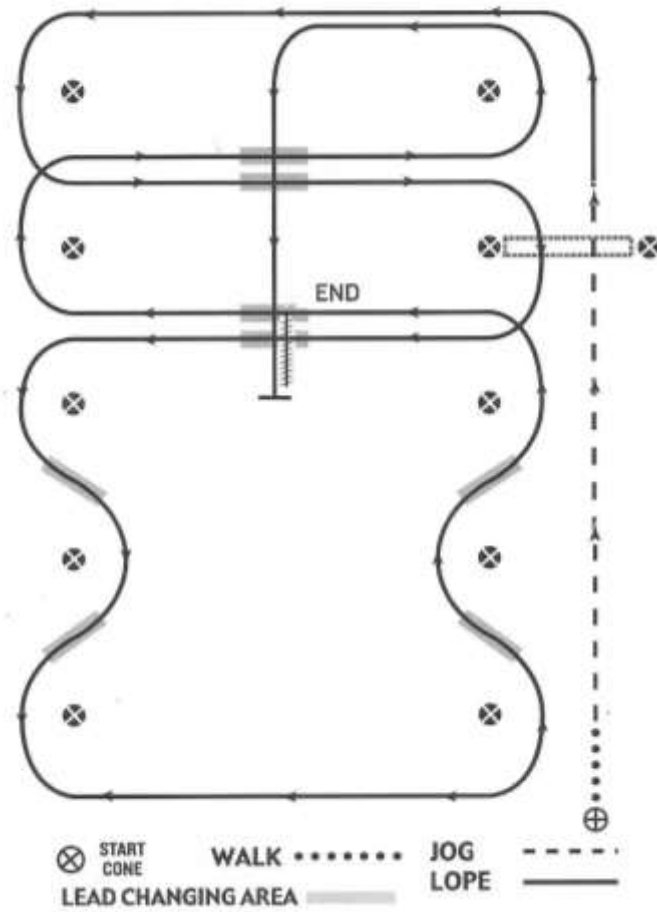

1. Walk at least 15 feet from start cone to the first marker, transition to jog or 1st gait, jog or 1st gait over log
2. Transition to the lope, on the left lead
3. First crossing change
4. Lope over log
5. Second crossing change
6. First line change
7. Second line change
8. Third line change
9. Fourth line change
10. Third crossing change
11. Fourth crossing change
12. Lope up the center, stop, and back

WESTERN RIDING PATTERN 4

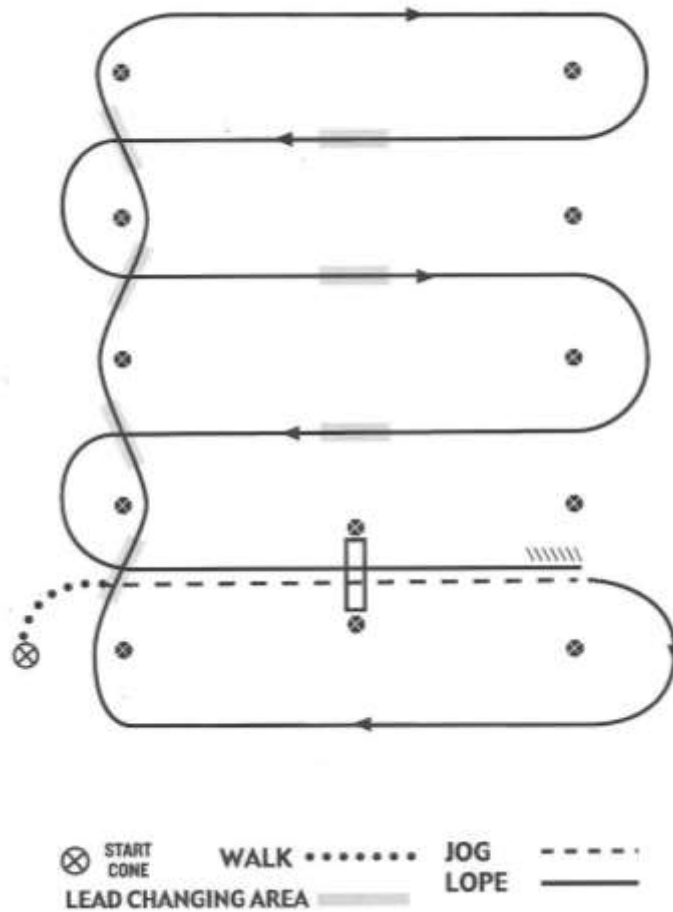

1. Walk at least 15 feet from start cone to the first marker, transition to jog or 1st gait, jog or 1st gait over log
2. Transition to the lope, on the right lead
3. First line change
4. Second line change
5. Third line change
6. Fourth line change
7. First crossing change
8. Second crossing change
9. Third crossing change
10. Lope over log
11. Lope, stop, and back

WESTERN RIDING PATTERN 5
Recommended For Small Arenas

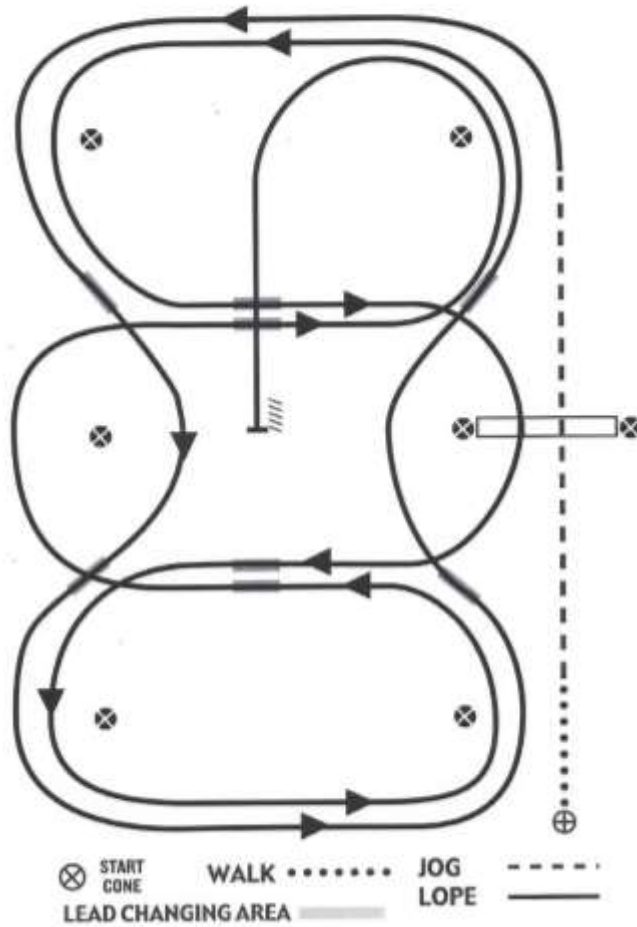

1. Walk at least 15 feet from start cone to the first marker, transition to jog or 1st gait, jog or 1st gait over log
2. Transition to the lope, on the left lead
3. First line change
4. Second line change
5. Third line change
6. Fourth line change
7. First crossing change
8. Lope over log
9. Second crossing change
10. Third crossing change
11. Fourth crossing change
12. Lope, stop, and back

LEVEL I WESTERN RIDING PATTERN I

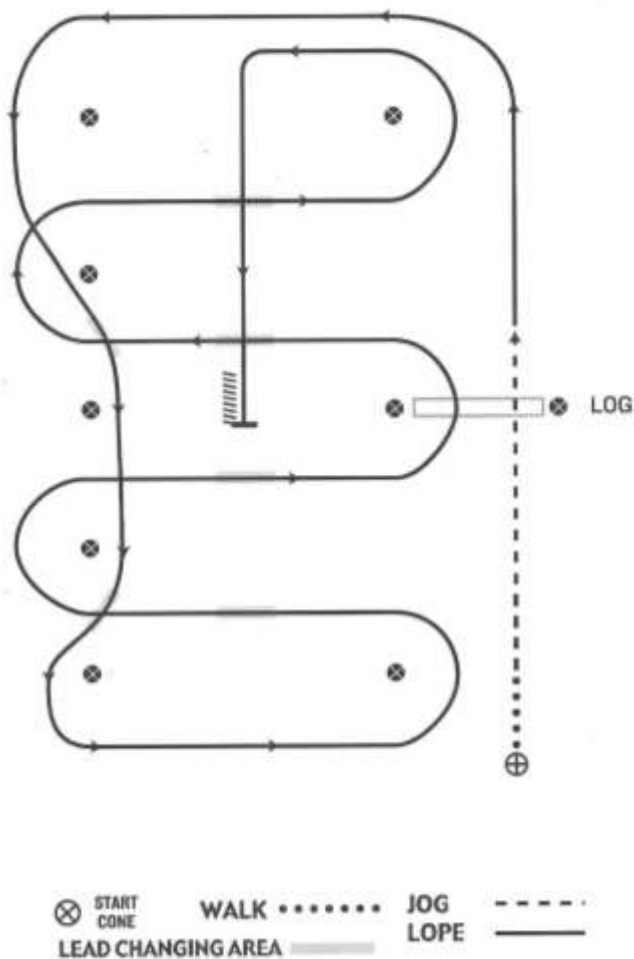

1. Walk at least 15 feet from start cone to the first marker, transition to jog or 1st gait, jog or 1st gait over log
2. Transition to left lead and lope around end
3. First line change
4. Second line change, lope around the end of arena
5. First crossing change
6. Second crossing change
7. Lope over log
8. Third crossing change
9. Fourth crossing change
10. Lope up the center, stop, and back

LEVEL I WESTERN RIDING PATTERN 2

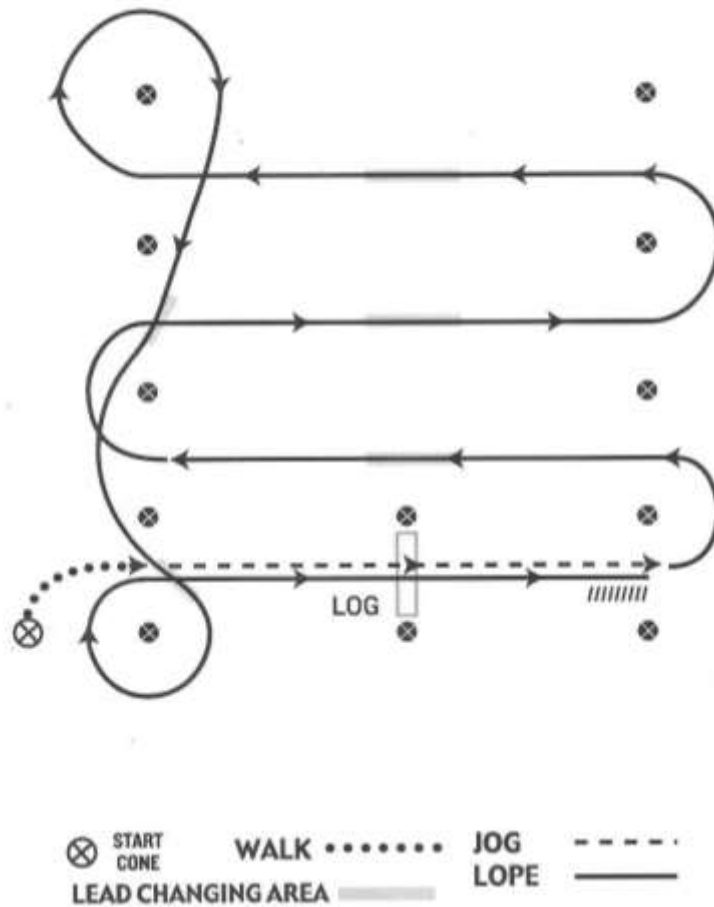

1. Walk at least 15 feet from start cone to the first marker, transition to jog or 1st gait, jog or 1st gait over log
2. Transition to left lead lope
3. First crossing change
4. Second crossing change
5. Third crossing change
6. Circle and first line change
7. Second line change and circle
8. Lope over log
9. Stop and back

LEVEL I WESTERN RIDING PATTERN 4

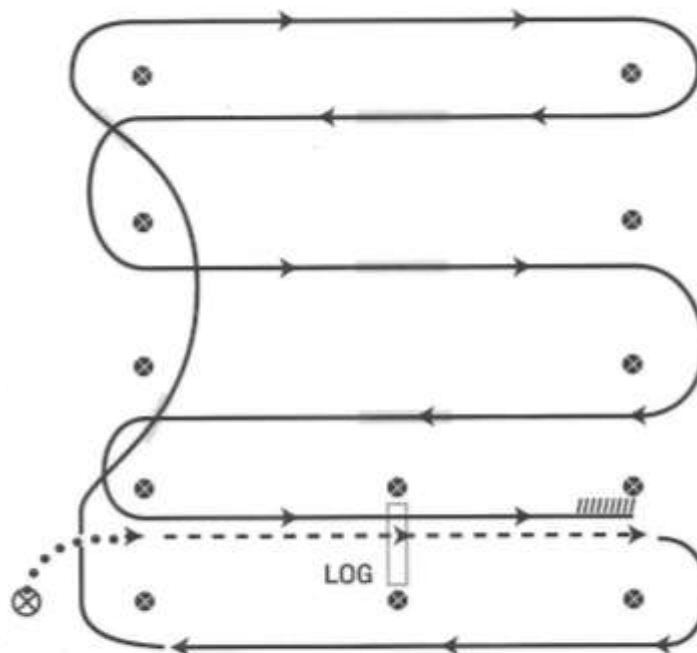

1. Walk at least 15 feet from start cone to the first marker, transition to jog or 1st gait, jog or 1st gait over log
2. Transition to right lead and lope around end
3. First line change
4. Second line change, lope around the end of arena
5. First crossing change
6. Second crossing change
7. Third crossing change
8. Lope over log
9. Lope, stop, and back

SCORING RUBRIC

SCORING. Exhibitors will be scored on a basis of 0-100 with 70 denoting an average performance. Points will be added or subtracted from the maneuvers on the following basis, ranging from plus 1.5 to minus 1.5: -1.5 extremely poor, -1 very poor, -.5 poor, 0 average, +.5 good, +1 very good, +1.5 excellent. Maneuver scores are to be determined independently of penalty points.

PENALTIES SHOULD BE ASSESSED EACH TIME THE FOLLOWING OCCUR:

One-half (1/2) point

- tick or light touch of log

One (1) point

- hitting or rolling log
- out of lead more than one stride either side of the center point and between the markers
- splitting the log (log between the two front or two hind feet) at the lope
- hind legs skipping or coming together during lead change
- break of gait at the walk or jog/1st gait up to two strides (4 steps = 2 strides – count the FRONT steps)
- non-simultaneous lead change (Front to hind or hind to front)

Three (3) points

- not performing the specific gait (jog/1st gait or lope) or not stopping when called for in the pattern, within 10 feet of the designated area
- simple change of leads
- out of lead at or before the marker prior to the designated change area or
- out of lead at or after the marker after the designated change area
- additional lead changes anywhere in pattern (except when correcting an
- extra change or incorrect lead)
- in pattern one and three failure to start the lope within 30 feet after crossing the log at the jog/1st gait
- break of gait at walk or jog/1st gait for more than two strides
- break of gait at the lope

Five (5) points

- out of lead beyond the next designated change area (note: failures to change, including cross-cantering. Two consecutive failures to change would result in two five point penalties)
- blatant disobedience including kicking out, biting, bucking, and rearing
- holding saddle with either hand
- use of either hand to instill fear or praise

Disqualified - 0 score

- illegal equipment
- willful abuse
- off course
- knocking over markers
- completely missing log
- major refusal - stop and back more than 2 strides (4 steps = 2 strides – count the FRONT steps)
- major disobedience or schooling
- failure to start lope prior to end cone in pattern #1
- failure to start lope within 30 feet of designated area in patterns 2, 3, 4, and 5 and Level 1 patterns 1, 2, and 4
- Overturn of more than ¼ turn

The following characteristics are considered faults and should be judged accordingly in maneuver scores:

- opening mouth excessively
- anticipating signals
- stumbling
- head carried too high
- head carried too low (tip of ear below the withers)
- over-flexing or straining neck in head carriage so the nose is carried behind the vertical
- excessive nosing out

Credits

- changes of leads, hind and front simultaneously
- change of lead near the center point of the lead change area
- accurate and smooth pattern
- even pace throughout
- easy to guide and control with rein and leg
- manners and disposition
- conformation and fitness

Class specifications: See *“ISHSA Approved Class List”*.

Class default rule book: For situations that are not covered by the ISHSA rule book, ISHSA will default to the AQHA rule book for western riding classes. To stay compliant with changes in the equine industry, ISHSA will add or subtract patterns and or scoring rules for western riding immediately following the lead of such changes made by AQHA. ISHSA will follow suit without needing to specifically vote on the changes.

It is suggested that judge(s) post their score sheets following the completion of the class(es).

Patterns and score sheets are available on the AQHA website.

RULES FOR DRIVING CLASSES

General Regulations and appointments

1. Points are accumulated by the horse and not by the exhibitor.
2. The equipment required for all driving classes shall include a whip, collar, or breast collar with standard driving bridle. An open driving bridle is acceptable. Appropriate bits, including leverage bits, may be used. Overcheck or side checks permitted at the option of exhibitors. To be shown in appropriate two (2) or four (4) wheel vehicle suitable to the horse. Breeching or thimbles may be used at the option of the exhibitor.
3. Entries shall be serviceably sound and shown without artificial appliances (i.e., wired ears).
4. Attire – Drivers (and passengers) should conform to the type of turnout and horse presented (i.e. pleasure, roadster, etc.) but should always be neat and clean. Appropriate attire for gentlemen includes hat, coat or jacket, shirt, pants, and tie. Appropriate attire for ladies includes tasteful dress, tailored suit, skirt, or slacks, with blouse, vest, or jacket. Hats, gloves and/or aprons/lap robes are optional unless otherwise noted for specific classes.
5. One passenger permitted. Any assistance to the driver will result in disqualification.
6. Horses/Pony greater than 40” may not be combined with Miniature/Pony 40” or less in any driving event.
7. Headers are optional, but recommended for all driving classes.
8. Headers are mandatory for all youth drivers, except where noted.
9. Headers are to be fourteen (14) years of age or older.
10. A driving whip shall be defined as a whip with a firm stock of suitable length for the horse being exhibited.
11. Drivers may not be asked to dismount the vehicle.
12. No bells, noise makers, or live passenger animals are allowed in any driving class.

Pleasure Driving

1. General Regulations and Requirements
 - a. Entries should give the appearance of being a pleasurable driving horse. To enter the ring at a normal trot if conditions allow.
 - b. Entries shall be shown with natural or shortened mane and tail. Non-conforming entries must be eliminated.
 - c. Boots or bandages are prohibited.
 - d. Entry number is to be clearly displayed.
 - e. To be shown at a flat-footed walk, a normal trot and a strong trot, both ways of the ring.
 - f. To stand quietly and back readily.
2. Gaits
 - a. All gaits to be performed in a smooth, relaxed, balanced manner, consistent with conformation type of animal.
 - b. Walk: Flat-footed, free, rhythmical four beat gait.
 - c. Normal Trot: Balanced, free moving and relaxed two beat gait.

- d. Strong Trot: Balanced lengthening of stride with noticeable difference from normal trot, without excessive speed, loss of form, or two beat gait.
 - i. Stock and Hunter Types will move with low strides, with little flexion of knees and hocks.
 - ii. Pleasure Type will move with rounded, medium strides, flexed neck with poll higher than withers, and will display forward reach and flexion of knees and hocks.
 - iii. Saddle Type will move with rounded strides and may display higher head carriage and action and more knee and hock flexion.
3. Judging
- a. To be judged on manners, quality, performance, conformation and suitability.
 - b. Faults would include: stiff or choppy gaits; inconsistent rhythm, crooked or sideways movement.
 - c. A tendency to move in a western style jog instead of a normal trot must be penalized.
 - d. All horses moving in an extremely slow jog instead of a normal trot must be penalized.
 - e. Extreme speed to be penalized.
 - f. To be shown at a flat-footed walk, a normal trot and a strong trot, both ways of the ring.
 - g. To stand quietly and back readily.

Roadster Driving

1. General Regulations and Requirements
 - a. Entries shall be serviceably sound and shown without artificial appliances.
 - b. Unweighted quarter boots or rubber bell boots are optional in all classes.
 - c. Entries shall be shown with natural or shortened mane and tail. Non-conforming entries must be eliminated.
 - d. Entry number to be clearly displayed.
2. Attire
 - a. Exhibitors shall wear stable colors, cap and jacket to match.
3. Gaits – The principle gait assignment for Roadsters is the trot. Entries shall be asked to trot at three different speeds: the slow jog trot, the fast road gait, and then at full speed.
 - a. At all speeds, horses should work in form, with chins set and legs working beneath them, going in a collected manner.
 - b. At the trot, an entry whose action features folding of knees, flexing of hocks, with straight, true action of front legs and with hocks carried close together and with motions coordinated, is executing a balanced trot. Long, sprawling action in front, dragging or trailing hind legs and straddle-gaited action behind makes a balanced trot impossible. Pacey-gaited or mixed-gaited entries, that pace and rack the turns, or break and run on the turns, shall be penalized.
4. Class Procedure
 - a. Roadsters must enter the ring clockwise at a jog trot, then show at the road gait; turn counter-clockwise at the jog trot, show at the road gait and then trot at speed.

- b. Entries should be light-mouthed, capable of being taken up at any time, willing to walk and stand well when being judged in the center of the ring.
- c. When entries are lined up, attendant is permitted and driver shall not leave his/her vehicle except for necessary adjustments.

Disciplined Rail Driving

1. General Regulations and Requirements

- a. This class is to show the ability of a highly trained horse.
- b. Give the appearance of being a pleasurable driving horse.
- c. To be shown in a two (2) or four (4) wheeled vehicle.
- d. Boots or bandages are prohibited.
- e. To stand quietly and back readily.
- f. To enter the ring at a normal trot.
- g. To be shown at a flat-footed walk, a normal trot, and a strong trot, both ways of the ring

2. Class Procedure

- a. Horses shall perform work on the rail that may include, but not be limited to:
 - i. A flat-footed walk, normal trot.
 - ii. A strong trot (not to exceed twice around the ring).
 - iii. Starting with a flat-footed walk, through a normal trot to a strong trot.
 - iv. Stand quietly.
 - v. Pivot (Horse to side pass as though there were a wall in front and behind with one (1) wheel rolling). Judge may ask for both right and left or either.
 - vi. May not ask driver to dismount the vehicle.

3. Judging

- a. Judge shall work the horses adequately, but must not overwork the entries. This is not a game or a fault-and-out class and shall not be judged on an elimination basis.
- b. Final judging shall be on the basis of the best overall disciplined rail performance.
- c. To be judged seventy-five (75%) percent on performance, and twenty-five (25%) percent on manners and conformation.

Class specifications:

See *“ISHSA Approved Class List”*.

Class default rule book: For situations that are not covered by the ISHSA rule book, ISHSA will default to the PtHA rule book for driving classes.

THIS PAGE INTENTIONALLY LEFT BLANK

RULES FOR TRAIL CLASSES

General:

1. Points are accumulated by the horse and not by the exhibitor.
2. This class will be judged on the performance of the horse over obstacles, with emphasis on manners, response to the rider and quality of movement. Credit will be given to horses negotiating the obstacles with style and some degree of speed, providing correctness is not sacrificed. Horses should receive credit for showing attentiveness to the obstacles and the capability of picking their own way through the course when obstacles warrant it, and willingly responding to the rider's cues on more difficult obstacles. Horses shall be penalized for any unnecessary delay while approaching or negotiating the obstacles. Horses with artificial appearance over obstacles should be penalized. Horses must not be required to work on the rail. The course must be designed, however, to require each horse to show the three gaits (walk or 1st gait, jog or 2nd gait, lope, except in walk/trot classes where no lope is required) somewhere between obstacles as a part of its work, and quality of movement and cadence should be considered as part of the maneuver score. While on the line of travel between obstacles, the horse shall be balanced, carrying his head and neck in a relaxed, natural position, with the poll level with or slightly above the withers. The head should not be carried behind the vertical, giving the appearance of intimidation, or be excessively nosed out, giving a resistant appearance.
3. All entered exhibitors will be allowed to walk and inspect the course with the judge and with the course designer, if present, prior to the start of the class. Horses are not allowed on the course prior to competition. This does not include paid warmup classes.
4. The judge has the right to alter the course in any manner or remove any obstacle deemed by the judge to be unsafe or non-negotiable. All courses and obstacles are to be constructed with safety in mind. If at any time a trail obstacle is deemed to be unsafe by the judge, it shall be repaired or removed from the courses. If it cannot be repaired and horses have completed the course, the score for that obstacle shall be deducted from all previous works for that class. No horse shall be asked to repeat the course except in the case of a tie.
5. The same exhibitor may enter and show two or more horses.
6. Boots and/or bandages are not permitted. Exceptions can be made for inclement weather or conditions. In the event of an injury, the judge may permit a protective bandage.
7. Measurements to be taken with accurate measuring device i.e. measuring tape, ruler, yard stick. Measurements to be taken from the inside width of poles or obstacles.
8. Pattern should be posted a minimum of one (1) hour prior to the start of the class.

Mounted trail

Appointments:

1. Refer to “*Rules for Western Pleasure Classes*”

General:

1. Horses are to be shown over and through obstacles at a walk, jog, and lope on a reasonably loose rein without undue restraint with the exception of walk/trot classes where no lope is required. Gaited horses will be required to show at 1st gait and 2nd gait in 2-gait classes and at 1st gait, 2nd gait, and lope in 3-gait classes. Gaited horses will only be asked to negotiate walk-overs or jog-overs at 1st gait, never at 2nd gait.
2. Course to include a minimum of six (6) obstacles. Three (3) of these must be from the “*mandatory obstacles*” list. The remainders are to be from the “*optional obstacles*” list.
3. Care in preparing the course should be exercised to prevent a direct advantage to either a small or large horse.
4. In case of a knockdown, the obstacle must be reset so to be equal and alike for all other horses.
5. Management is encouraged to design obstacle courses that can be negotiated in 90 seconds.

In-hand trail

Appointments:

1. Western attire is required. Refer to “*Rules for Western Pleasure Classes*”
2. A halter and lead are required. Chain is optional.
3. No bridles are allowed.
4. No whips or crops are allowed.
5. No horse that is being shown under saddle may compete in in-hand trail.

General:

1. Horses are to be shown over and through obstacles at a walk and jog without undue restraint. Gaited horses will be required to show at 1st gait and 2nd gait. Gaited horses will only be asked to negotiate walk-overs or jog-overs at 1st gait, never at 2nd gait.
2. Course to include a minimum of six (6) obstacles. Three (3) of these must be from the “*mandatory obstacles*” list. The remainders are to be from the “*optional obstacles*” list.
3. Care in preparing the course should be exercised to prevent a direct advantage to either a small or large horse. Course should be designed with the young horse in mind.
4. In case of a knockdown, the obstacle must be reset so to be equal and alike for all other horses.
5. Management is encouraged to design obstacle courses that can be negotiated in 90 seconds.
6. Handler may touch the horse with hands for cues.

Mandatory obstacles:

1. Gate.
 - a. The gate should be approximately 60 inches high with a latch available at that height.
 - b. Gate should be constructed of a material that will not endanger the horse or rider/handler.
 - c. Rider/handler will be required to open, pass through, and close the gate. Changing hands on the gate or turning loose of the gate will be penalized.
 - d. If the gate has a metal, plastic, or wooden support bar under the opening, contestants must work the gate moving forward through it.
 - e. Riders competing in 11 years and under walk/trot (cannot cross-enter) classes will be required to pass through an open gate, do not open and close the gate.
2. Logs or poles.
 - a. Riders/handlers will be required to negotiate over at least four (4) logs or poles. These can be in a straight line, curved, zigzagged, or elevated.
 - b. In mounted trail, riders may be asked to perform walk-overs, jog-overs, and/or lope-overs.
 - c. In in-hand trail, handlers may be asked to perform walk-overs and/or jog-overs.
 - d. The distance between logs is to be measured at the point where the horse is to cross the log. The dimensions and some diagrams of possible configurations of logs follow. Courses are not limited to using these configurations, but they must comply with the standard dimensions.
 - e. All elevated elements must be placed in a cup, notched block, or otherwise secured so they cannot roll. Height should be measured from the ground to the top of the element.
 - f. Rolling logs or poles are prohibited.
 - g. Gaited horses will only be asked to negotiate logs or poles at 1st gait, never at 2nd gait.

Walk-overs:

- a. Width between logs: 20 – 24 inches or increments thereof.
- b. Elevated walk-overs, maximum height:
 - i. Ponies greater than 40” and horses--12 inches for single poles.
 - i. Miniature horses and ponies 40” or less--8 inches
 - ii. Ponies greater than 40” and horses--10 inches for multiple poles.
 - i. Miniature horses and ponies 40” or less--6 inches
- c. Elevated walk-overs should be at least 22 inches apart.

Jog-overs:

- a. The spacing for jog-overs shall be 3 feet to 3 feet 6 inches or increments thereof.
- b. Jog-overs may be elevated to
 - i. Ponies greater than 40” and horses--8 inches
 - ii. Miniature horses and ponies 40” or less—6 inches

Lope-overs:

- a. The spacing for lope-overs shall be 6 – 6 ½ feet or increments thereof.
- b. Lope-overs may be elevated to 8 inches.

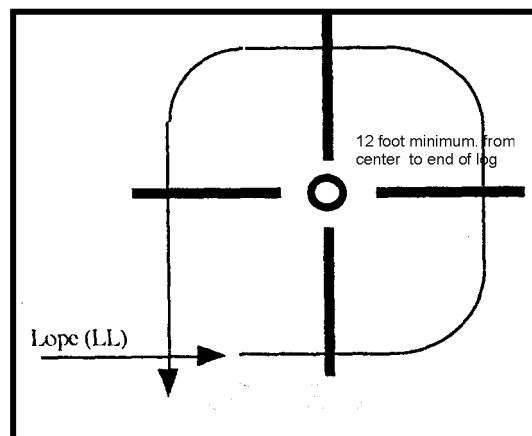
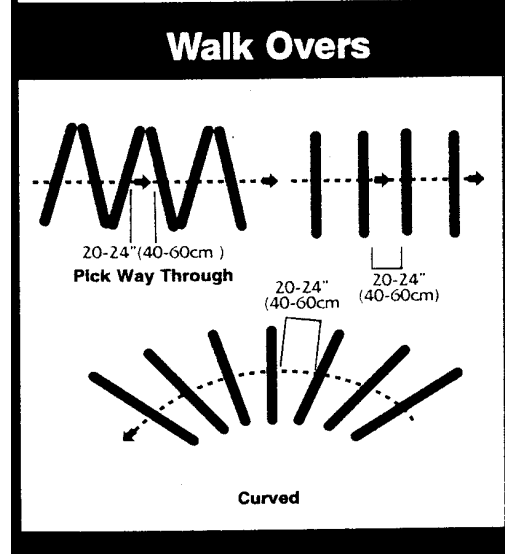
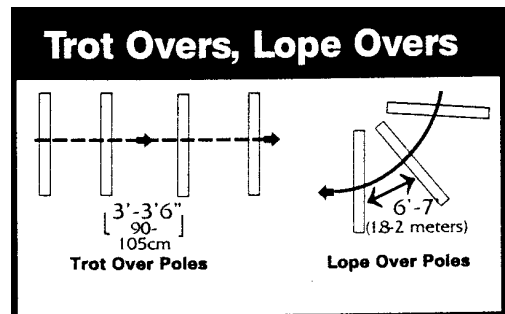
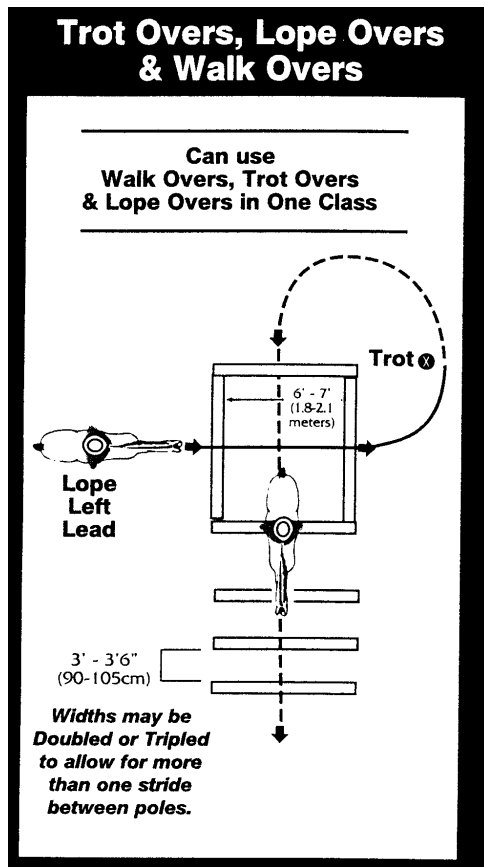

Walk, jog, or lope a spoke. The diagram shows a spoke performed with a left lead lope.

3. Back through.
 - a. Back through an "L", "V", "U", straight, or similarly shaped course. May be elevated no more than 24 inches.
 - b. The dimensions and some diagrams of possible configurations of back throughs follow. Courses are not limited to using these configurations, but they must comply with the standard dimensions.
 - i. On ground obstacle, minimum distance between: 28 inches
 - ii. Elevated obstacle
 1. minimum distance between: 30 inches
 2. maximum height: 24 inches
 - iii. Barrels, minimum distance between: 32 inches
 - iv. Back through and around at least three markers.
 - c. Entrants cannot be asked to back over a stationary object such as a wooden pole or metal bar.

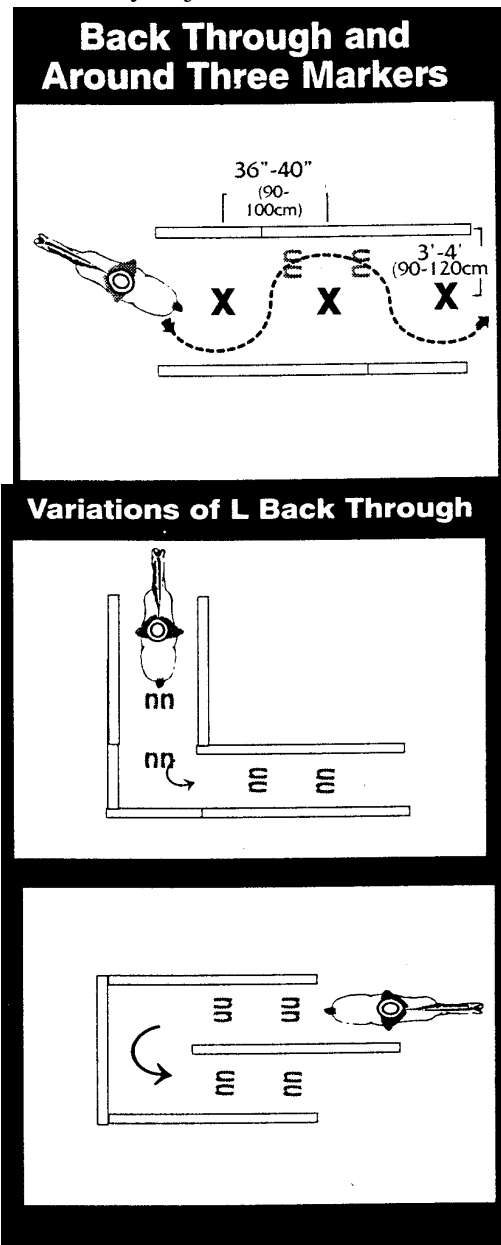
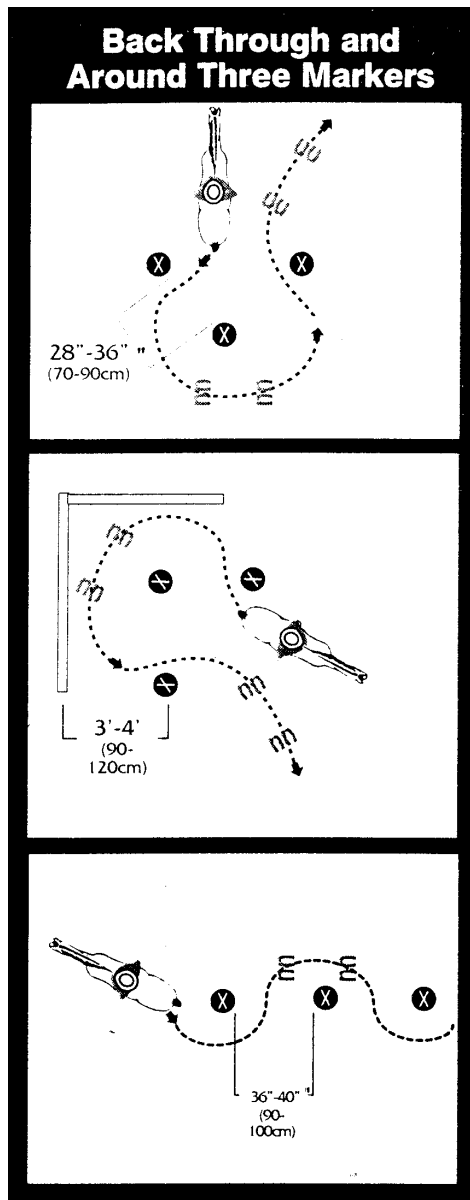

Optional obstacles:

1. Bridge. Ride over a wooden bridge in mounted trail or lead over a wooden bridge in in-hand trail. The suggested minimum width of the bridge is 36 inches wide and at least 6 feet long. Bridge should be sturdy and safe. No rolling bridge is allowed. Bridge should not exceed 12 inches in height. Bridge may be negotiated at the walk/1st gait only.
2. Water hazard. A water hazard is defined as a ditch or small pond. No metal or slick bottom boxes may be used.
3. Carry objects from one part of the arena to another. Only objects that reasonably might be carried (not drug) on a trail ride may be used. No live or dead animals may be used as an object to be carried.
4. Put on and remove slicker that is located so that the rider/handler can easily reach the slicker. In mounted trail, the reins may be held, dropped on the horse's neck, or placed around the saddle horn while the rider puts on and removes the slicker.
5. Remove and replace materials from a mailbox.
6. Box. An obstacle consisting of four (4) logs laid in a square. The box shall be a minimum of a six (6) foot square. Each contestant will enter the square as designated. When all four feet are inside the square, horse should execute a turn, as indicated, and depart. The diagram below shows a possible box obstacle execution. Courses are not limited to using this configuration, but they must comply with the standard dimensions.

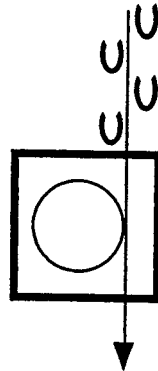

7. Side pass. The dimensions and some diagrams of possible configurations of side passes follow. Courses are not limited to using these configurations, but they must comply with the standard dimensions show in the diagrams. May be elevated to 12 inches maximum.

Variations of Sidepass

5'-6"
(1.5-1.8 meters)

SIDEPASS RIGHT, TURN RIGHT
SIDEPASS LEFT

20-24"
(40-60 cm)

FRONT FEET INSIDE OR
BACK FEET INSIDE

RAISED OBJECT
no more than 12" (30 cm)

Variations of Sidepass

22 - 24"
(50-60cm)

8. Serpentine obstacles at a walk/1st gait or a jog/2nd gait.
 - a. Pylon spacing to be a minimum distance of 6 feet, base to base, for the jog/2nd gait.
9. A combination of two or more of any obstacle is acceptable.
10. Any other safe and negotiable obstacle which could reasonably be expected to be encountered on a trail ride and meets the approval of the judge may be used.

Unacceptable obstacles:

1. Tires
2. Animals
3. Hides
4. PVC pipe
5. Dismounting
6. Jumps
7. Rocking or moving bridges
8. Water box with floating or moving parts
9. Flames, dry ice, fire extinguisher, etc.
10. Logs or poles elevated in a manner that permits such to roll.
11. Ground ties.

SCORING RUBRIC

Definitions:

Knockdown: When any component, element, or portion of an obstacle is displaced from its original position--by horse or rider/handler.

Refusal: Any action taken by the horse to avoid performing an obstacle, part of a combination of obstacles or portion of a trail course. These actions may include, but are not limited to the following:

- a. **Balking:** any action that results in a horse blatantly and continuously refusing a rider's/handler's command.
- b. Evading or running past an obstacle to be negotiated.
- c. Each complete loss of the gate.
- d. Any blatant action by the horse that demonstrates unwillingness to approach, negotiate and/or complete an obstacle.

Off course:

- a. Taking an obstacle in the wrong direction.
- b. Negotiating an obstacle from the wrong side.
- c. Skipping an obstacle unless directed by the judge.
- d. Negotiating obstacles in the wrong sequence.
- e. Not following the correct line of travel drawn on the pattern.

SCORING. Scoring will be on the basis of 0-infinity, with 70 denoting an average performance. Each obstacle will receive an obstacle score that should be added or subtracted from 70 and is subject to a penalty that should be subtracted. Each obstacle will be scored on the following basis, ranging from plus 1 1/2 to minus 1 1/2: -1 1/2 extremely poor, -1 very poor, -1/2 poor, 0 correct, +1/2 good, +1 very good, +1 1/2 excellent. Obstacle scores are to be determined and assessed independently of penalty points.

PENALTIES SHOULD BE ASSESSED, PER OCCURRENCE, AS FOLLOWS:

One-half (1/2) point

- each tick or contact of a log, pole, cone, plant, or any component of an obstacle

One (1) point

- each hit, bite, or stepping on a log, cone, plant or any component of the obstacle
- incorrect or break of gait at walk or jog for two strides (4 steps = 2 strides – count the FRONT steps) or less
- both front or hind feet in a single-strided slot or space at a walk or jog
- skipping over or failing to step into required space
- split pole in lope-over
- incorrect number of strides, if specified

Three (3) point

- incorrect or break of gait at walk or jog for more than 2 strides (4 steps = 2 strides – count the FRONT steps)
- out of lead or break of gait at lope (except when correcting an incorrect lead)
- knocking down an elevated pole, cone, barrel, plant, obstacle, or severely disturbing an obstacle
- falling or jumping off or out of a bridge or a water box with one foot once the horse has got onto or into that obstacle
- Stepping outside of the confines of an obstacle with designated boundaries (i.e. back through, 360 box, side pass) with one foot once the horse has entered the obstacle.
- Missing or evading a pole that is a part of a series of an obstacle with one foot

Five (5) point

- dropping slicker or object required to be carried on course
- first or second cumulative refusal, balk, or evading an obstacle by shying or backing
- letting go of gate or dropping rope gate
- use of either hand to instill fear or praise
- falling or jumping off or out of a bridge or a water box with more than one foot once the horse has got onto or into that obstacle
- Stepping outside of the confines of an obstacle with designated boundaries (i.e. back through, 360 box, side pass) with more than one foot once the horse has entered the obstacle
- Missing or evading a pole that is a part of a series of an obstacle with more than one foot
- blatant disobedience (including kicking out, bucking, rearing, striking)
- holding saddle with either hand

Disqualified 0 – Score

- use of two hands (except in snaffle bit or hackamore classes designated for two hands) or changing hands on reins; except for junior horses shown with hackamore or snaffle bit, only one hand may be used on the reins, except that it is permissible to change hands to work an obstacle as outlined in “*Rules for Western Pleasure Classes*”, or to straighten reins when stopped
- use of romal other than as outlined in “*Rules for Western Pleasure Classes*”
- performing the obstacle incorrectly or other than in specified order
- no attempt to perform an obstacle
- equipment failure that delays completion of pattern
- excessively or repeatedly touching the horse on the neck to lower the head
- entering or exiting an obstacle from the incorrect side or direction

- working obstacle the incorrect direction; including overturns of more than 1/4 turn
- riding outside designated boundary marker of the arena or course area
- third cumulative refusal, balk, or evading an obstacle by shying or backing
- failure to ever demonstrate correct lead and/or gait as designated
- failure to follow the correct line of travel between obstacles
- excessive schooling, pulling, turning, stepping or backing anywhere on course
- failure to open and shut gate (except in classes where it is mandated to walk through an open gate) or failure to complete gate.

Faults scored according to severity which occur on the line of travel between obstacles include:

- head carried too low (tip of ear below the withers)
- over-flexing or straining neck in head carriage so the nose is carried behind the vertical
- excessive nosing out
- opening mouth excessively

Class specifications: For all trail classes, see “*ISHSA Approved Class List*”.

Class default rule book: For situations that are not covered by the ISHSA rule book, ISHSA will default to the AQHA rule book for trail classes. To stay compliant with changes in the equine industry, ISHSA will add or subtract obstacles and or scoring rules for trail immediately following the lead of such changes made by AQHA. ISHSA will follow suit without needing to specifically vote on the changes.

It is suggested that judge(s) post their score sheets following the completion of the class(es).

Trail score sheets are available on the AQHA website.

Sample trail course taken from the AQHA rule book for the purpose of showing dimensions between obstacles.

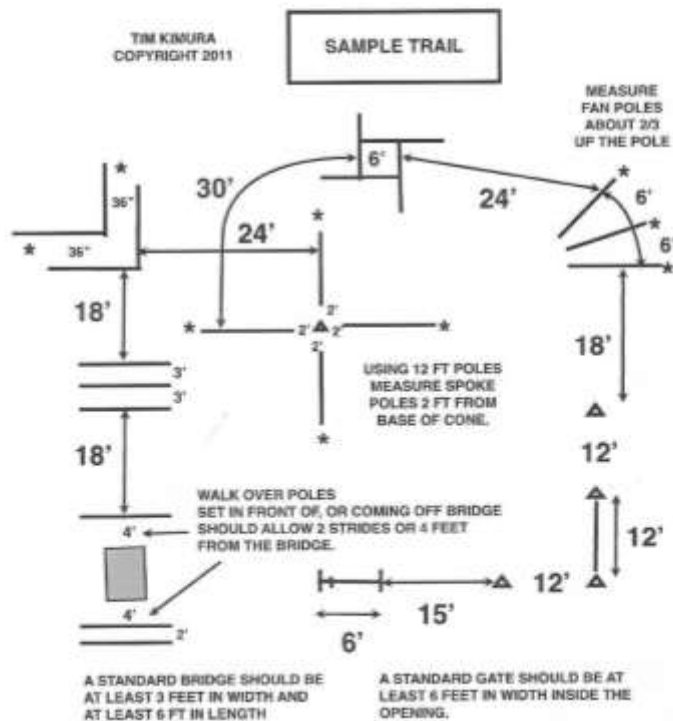
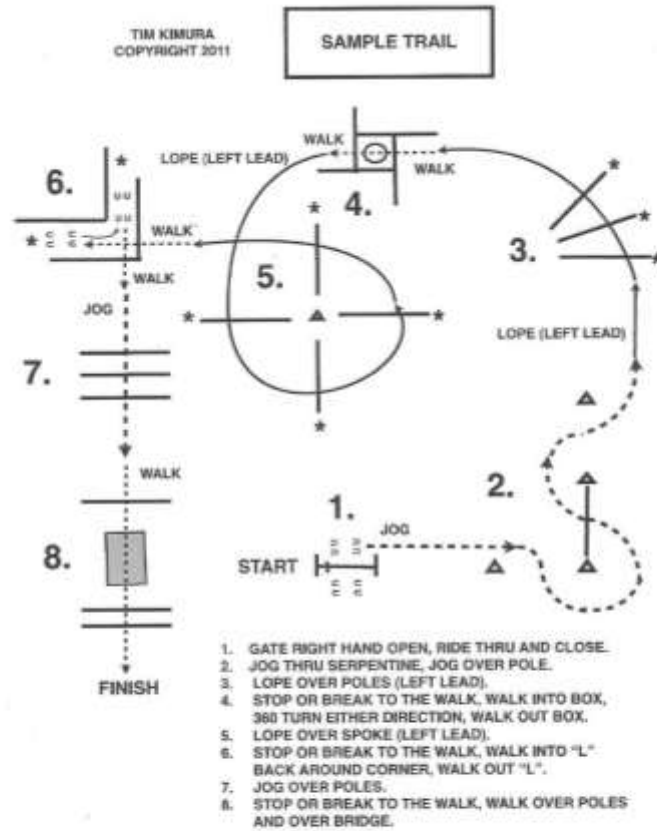

RULES FOR REINING CLASSES

General:

1. Points are accumulated by the horse and not by the exhibitor.
2. Reining is a judged event designed to show the athletic ability of a ranch type horse in the confines of a show arena. In reining competition, contestants are required to run one of several approved patterns. Each pattern includes small slow circles, large fast circles, flying lead changes, rollbacks over the hocks, a series of 360-degree spins done in place, and the exciting sliding stops that are the hallmark of the reining horse. To rein a horse is not only to guide him, but also to control his every movement. The best-reined horse should be willingly guided or controlled with little or no apparent resistance and dictated to completely. Any movement on his own must be considered a lack of control. Any one of the approved reining patterns may be used and is to be selected by the judge of the class and used by all contestants in the class. Each contestant will perform the required pattern individually and separately. All horses will be judged immediately upon entering the arena. Any fault incurred prior to the commencement of a pattern will be scored accordingly. All deviations from the exact written pattern must be considered a lack of or temporary loss of control, and therefore faulted according to severity of deviation. Credit will be given for smoothness, finesse, attitude, quickness and authority in performing the various maneuvers, while using controlled speed.
3. Riders may ride multiple equines, but an equine may only compete ONCE in a given class.
4. All reining patterns are to be run as written, not as drawn. Reining patterns 2, 4, 5, 6, 8, 11, and 13 are to start in the geographic center of the arena.
5. Pattern should be posted a minimum of one (1) hour prior to the start of the class.

Appointments:

Refer to "*Rules for Western Pleasure*". Protective leg wear on the horse is optional.

Patterns: *Refer to diagrams.*

1. The following patterns are to be worked as stated, not as drawn. The drawn pattern is just to give the general idea of what the pattern will look like in the arena.
2. All judges' decisions are final.

Pattern 1

1. Run at speed to the far end of the arena past the end marker and do a left rollback - no hesitation.

2. Run to the opposite end of the arena past the end marker and do a right rollback - no hesitation.

3. Run past the center mark and do a sliding stop. Back up to center of the arena or at least ten feet. Hesitate.

4. Complete four spins to the right. Hesitate.

5. Complete four and one-quarter spins to the left so that horse is facing left wall or fence. Hesitate.

6. Beginning on the left lead, complete three circles to the left: the first circle large and fast; the second circle small and slow; the third circle large and fast. Change leads at the center of the arena.

7. Complete three circles to the right: the first circle large and fast; the second circle small and slow; the third circle large and fast. Change leads at the center of the arena.

8. Begin a large fast circle to the left but do not close this circle. Run straight up the right side of the arena past the center marker and do a sliding stop at least twenty feet from the wall or fence. Hesitate to demonstrate the completion of the pattern.

Rider may be asked to dismount and drop bridle to the designated judge.

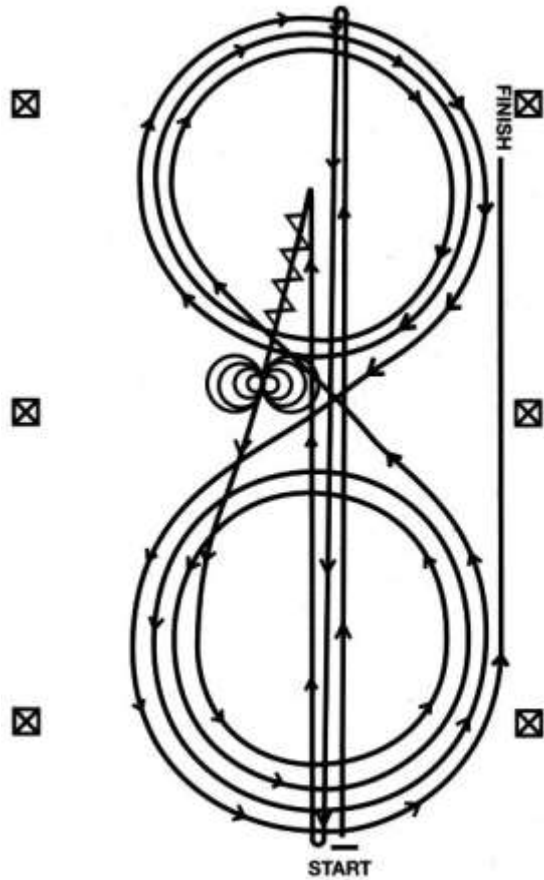

Pattern 2

Horses may walk or trot to the center of arena.
Horses must walk or stop prior to starting pattern. Beginning at the center of the arena facing the left wall or fence.

1. Beginning on the right lead, complete three circles to the right: the first circle small and slow; the next two circles large and fast. Change leads at the center of the arena.

2. Complete three circles to the left: the first circle small and slow; the next two circles large and fast. Change leads at the center of the arena.

3. Continue around previous circle to the right. At the top of the circle, run down the middle to the far end of the arena past the end marker and do a right rollback - no hesitation.

4. Run up the middle to the opposite end of the arena past the end marker and do a left rollback - no hesitation.

5. Run past the center marker and do a sliding stop. Back up to the center of the arena or at least ten feet. Hesitate.

6. Complete four spins to the right. Hesitate.

7. Complete four spins to the left. Hesitate to demonstrate the completion of the pattern.

Rider may be asked to dismount and drop bridle to the designated judge.

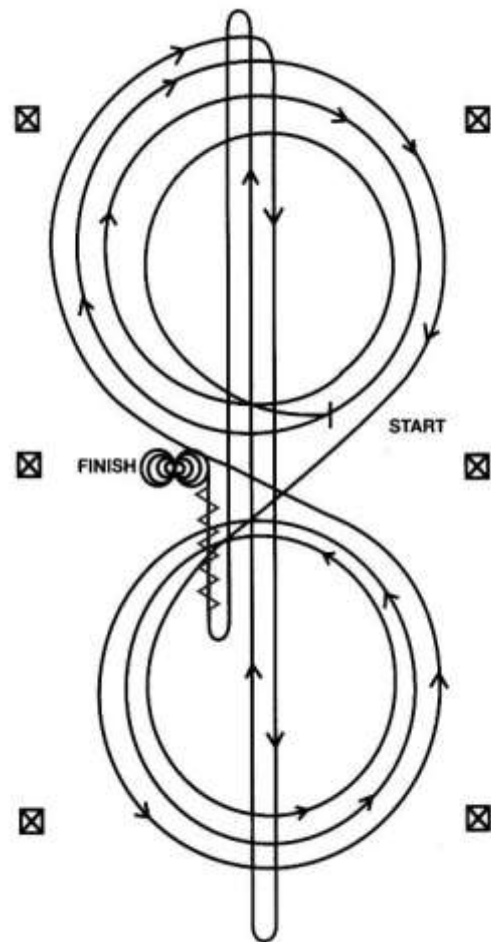

Pattern 3

1. Beginning, lope straight up the left side of the arena, circle the top end of the arena, and staying at least twenty feet from the walls or fence, run straight down the opposite or right side of the arena past the center marker and do a left rollback - no hesitation.

2. Continue straight up the right side of the arena, circle back around the top of the arena, and staying at least twenty feet from the walls or fence, run straight down the left side of the arena past the center marker and do a right rollback - no hesitation.

3. Continue up the left side of the arena to the center marker. At the center marker, the horse should be on the right lead. Guide the horse to the center of the arena on the right lead and complete three circles to the right: the first two circles large and fast; the third circle small and slow. Change leads at the center of the arena.

4. Complete three circles to the left: the first two circles large and fast; the third circle small and slow. Change leads in the center of the arena.

5. Begin a large fast circle to the right but do not close this circle. Continue up the left side of the arena, circle the top of the arena, and staying at least twenty feet from the walls or fence, run straight down the opposite or right side of the arena past the center marker and do a sliding stop. Back up at least ten feet. Hesitate.

6. Complete four spins to the right. Hesitate.

3. Complete four spins to the left. Hesitate to demonstrate completion of the pattern.

Rider may be asked to dismount and drop bridle to the designated judge.

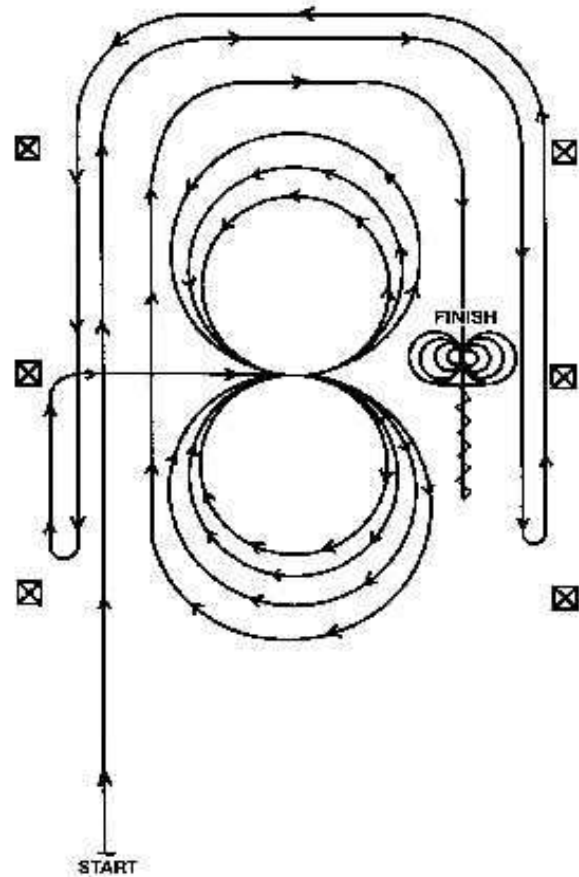

Pattern 4

Horses may walk or trot to the center of arena.
Horses must walk or stop prior to starting pattern. Beginning at the center of the arena facing the left wall or fence.

1. Beginning on the right lead, complete three circles to the right: the first two circles large and fast; the third circle small and slow. Stop at the center of the arena. Hesitate.

2. Complete four spins to the right. Hesitate.

3. Beginning on the left lead, complete three circles to the left: the first two circles large and fast; the third circle small and slow. Stop at the center of the arena. Hesitate.

4. Complete four spins to the left. Hesitate.

5. Beginning on the right lead, run a large fast circle to the right, change leads at the center of the arena, run a large fast circle to the left, and change leads at the center of the arena. (Figure 8)

6. Continue around previous circle to the right. At the top of the circle, run down the middle to the far end of the arena past the end marker and do a right rollback - no hesitation.

7. Run to the middle to the opposite end of the arena past the end marker and do a left rollback - no hesitation.

8. Run past the center marker and do a sliding stop. Back up to the center of the arena or at least ten feet. Hesitate to demonstrate completion of the pattern.

Rider may be asked to dismount and drop bridle to the designated judge.

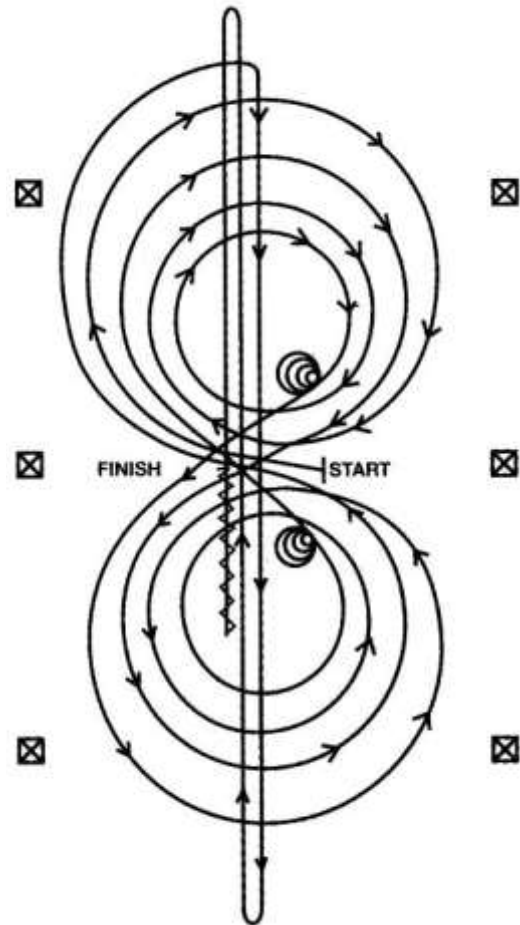

Pattern 5

Horses may walk or trot to the center of arena. Horses must walk or stop prior to starting pattern. Beginning at the center of the arena facing the left wall or fence.

1. Beginning on the left lead, complete three circles to the left: the first two circles large and fast; the third circle small and slow. Stop at the center the arena. Hesitate.

2. Complete four spins to the left. Hesitate.

3. Beginning on the right lead, complete three circles to the right: the first two circles large and fast; the third circle small and slow. Stop at the center the arena. Hesitate.

4. Complete four spins to the right. Hesitate.

5. Beginning on the left lead, run a large fast circle to the left, change leads at the center of the arena, run a large fast circle to the right, and change leads at the center of the arena. (Figure 8)

6. Continue around previous circle to the left but do not close this circle. Run up the right side of the arena past the center marker and do a right rollback at least twenty feet from the wall or fence - no hesitation.

7. Continue around previous circle but do not close this circle. Run up the left side of the arena past the center marker and do a left rollback at least twenty feet from the wall or fence - no hesitation.

8. Continue back around previous circle but do not close this circle. Run up the right side of the arena past the center marker and do a sliding stop at least twenty feet from the wall or fence. Back up at least ten feet. Hesitate to demonstrate completion of the pattern.

Rider may be asked to dismount and drop bridle to the designated judge.

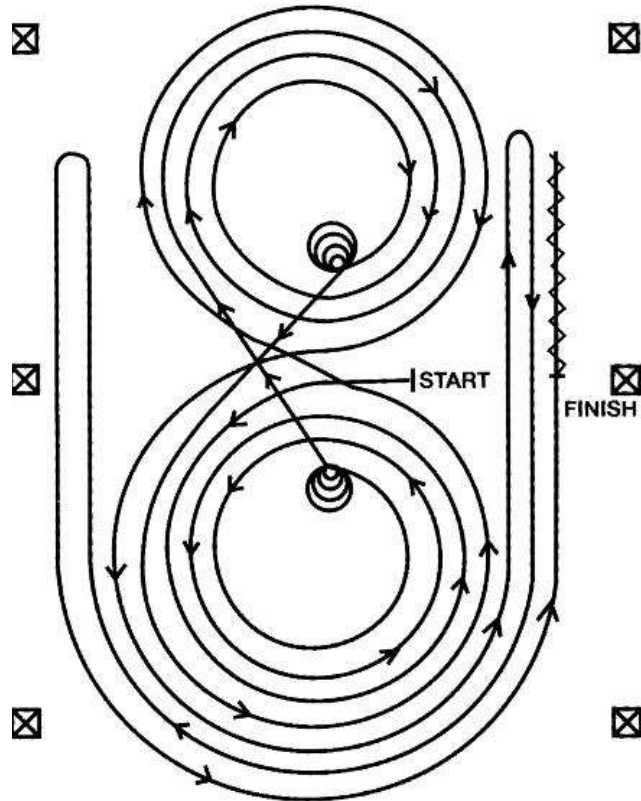

Pattern 6

Horses may walk or trot to the center of arena. Horses must walk or stop prior to starting pattern. Beginning at the center of the arena facing the left wall or fence.

1. Complete four spins to the right. Hesitate.

2. Complete four spins to the left. Hesitate.

3. Beginning on the left lead, complete three circles to the left: the first two circles large and fast; the third circle small and slow. Change leads at the center of the arena.

4. Complete three circles to the right: the first two circles large and fast; the third circle small and slow. Change leads at the center of the arena.

5. Begin a large fast circle to the left but do not close this circle. Run up the right side of the arena past the center marker and do a right rollback at least twenty feet from the wall or fence - no hesitation.

6. Continue back around previous circle but do not close this circle. Run up the left side of the arena past the center marker and do a left rollback at least twenty feet from the wall or fence - no hesitation.

7. Continue back around previous circle but do not close this circle. Run up the right side of the arena past the center marker and do a sliding stop at least twenty feet from the wall or fence. Back up at least ten feet. Hesitate to demonstrate the completion of the pattern.

Rider may be asked to dismount and drop bridle to the designated judge.

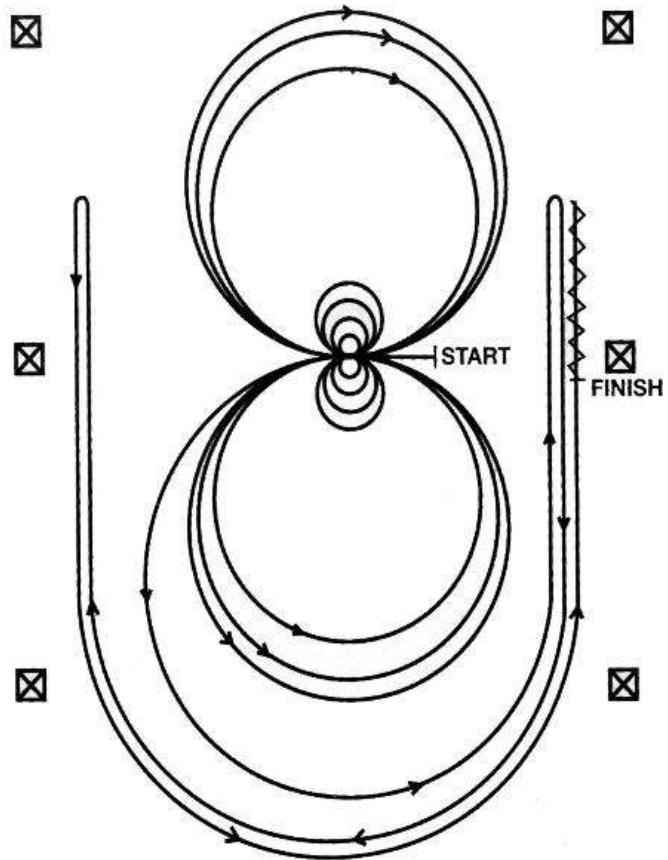

Pattern 7

1. Run at speed to the far end of the arena past the end marker and do a left rollback - no hesitation.

2. Run to the opposite end of the arena past the end marker and do a right rollback - no hesitation.

3. Run past the center marker and do a sliding stop. Back up to the center of the arena or at least ten feet. Hesitate.

4. Complete four spins to the right. Hesitate.

5. Complete four and one-quarter spins to the left so that horse is facing left wall or fence. Hesitate.

6. Beginning on the right lead, complete three circles to the right: the first two circles large fast; the third circle small and slow. Change leads at the center of the arena.

7. Complete three circles to the left: the first two circles large fast; the third circle small and slow. Change leads at the center of the arena.

8. Begin a large fast circle to the right but do not close this circle. Run straight down the right side of the arena past the center marker and do a sliding stop at least twenty feet from the wall or fence. Hesitate to demonstrate completion of the pattern.

Rider may be asked to dismount and drop bridle to the designated judge.

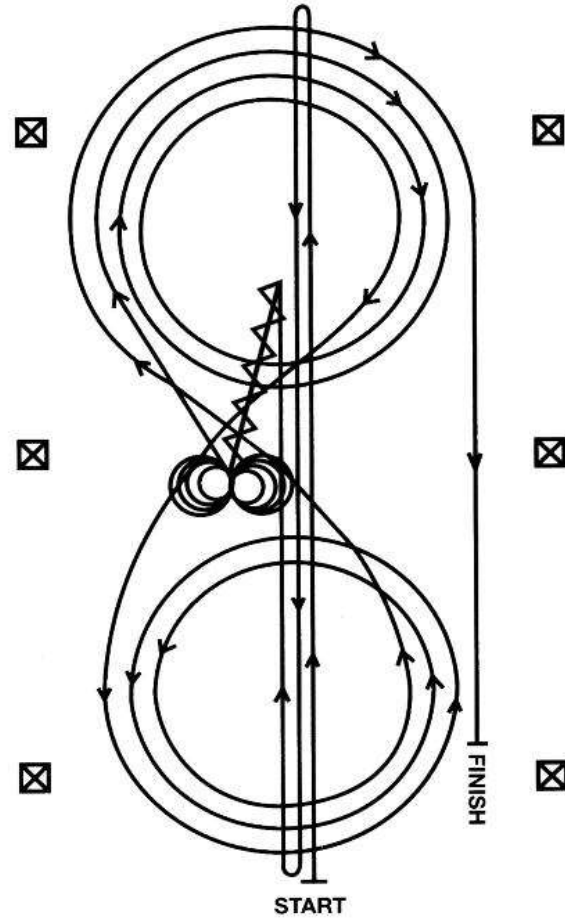

Pattern 8

Horses may walk or trot to the center of arena. Horses must walk or stop prior to starting pattern. Beginning at the center of the arena facing the left wall or fence.

1. Complete four spins to the left. Hesitate.

2. Complete four spins to the right. Hesitate.

3. Beginning on the right lead, complete three circles to the right: the first circle large and fast; the second circle small and slow; the third circle large and fast. Change leads at the center of the arena.

4. Complete three circles to the left: the first circle large and fast; the second circle small and slow; the third circle large and fast. Change leads at the center of the arena.

5. Begin a large fast circle to the right but do not close this circle. Run straight down the right side of the arena past the center marker and do a left rollback at least twenty feet from the wall or fence - no hesitation.

6. Continue back around the previous circle but do not close this circle. Run down the left side of the arena past the center marker and do a right rollback at least twenty feet from the wall or fence - no hesitation.

7. Continue back around the previous circle but do not close this circle. Run down the right side of the arena past the center marker and do a sliding stop at least twenty feet from the wall or fence. Back up at least ten feet. Hesitate to demonstrate completion of the pattern.

Rider may be asked to dismount and drop bridle to the designated judge.

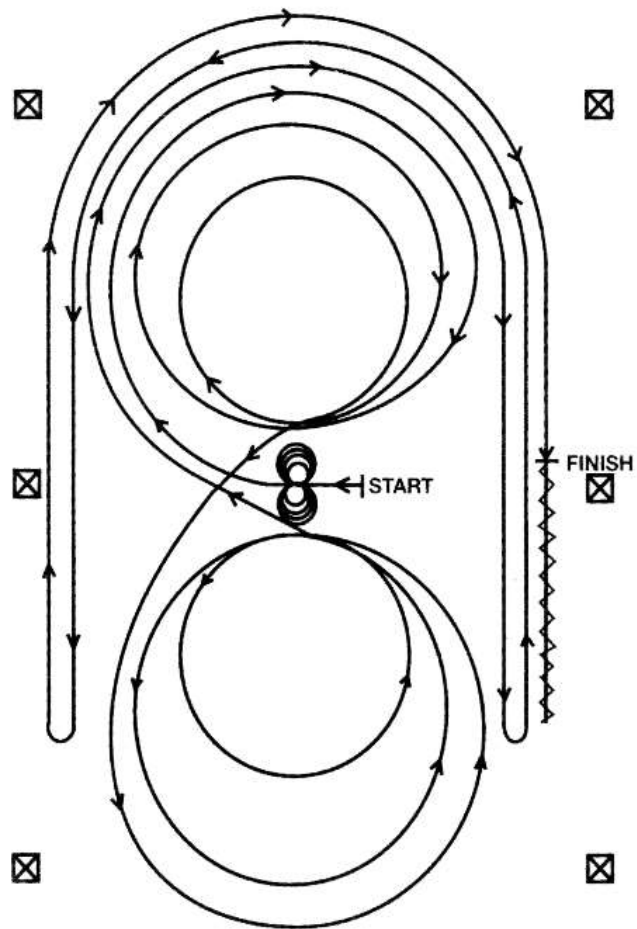

Pattern 9

1. Run past the center marker and do a sliding stop. Back up to the center of the arena or at least ten feet. Hesitate.

2. Complete four spins to the right. Hesitate.

3. Complete four and one-quarter spins to the left so that horse is facing the left wall or fence. Hesitate.

4. Beginning on the left lead, complete three circles to the left, the first circle small and slow; the next two circles large and fast. Change leads at the center of the arena.

5. Complete three circles to the right: the first circle small and slow; the next two circles large and fast. Change leads at the center of the arena.

6. Begin a large fast circle to the left but do not close this circle. Run up the right side of the arena past the center marker and do a right rollback at least twenty feet from the wall or fence - no hesitation.

7. Continue back around the previous circle but do not close this circle. Run up the left side of the arena past the center marker and do a left rollback at least twenty feet from the wall or fence - no hesitation.

8. Continue back around previous circle but do not close this circle. Run up right side of the arena past the center marker and do a sliding stop at least twenty feet from the wall or fence. Hesitate to demonstrate completion of the pattern.

Rider may be asked to dismount and drop bridle to the designated judge.

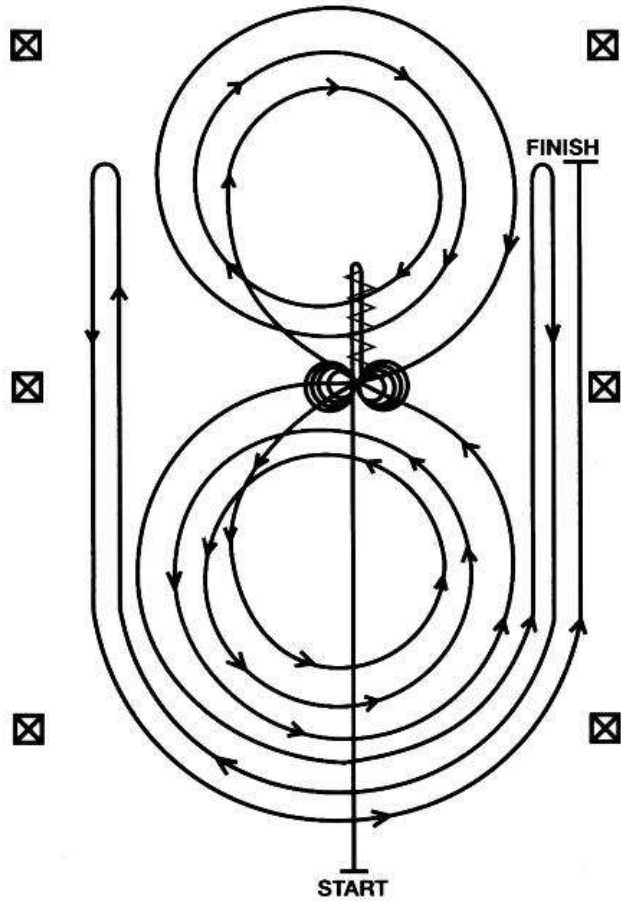

Pattern 10

1. Run past the center marker and do a sliding stop. Back up to the center of the arena or at least ten feet. Hesitate.

2. Complete four spins to the right. Hesitate.

3. Complete four and one-quarter spins to the left so that horse is facing the left wall or fence. Hesitate.

4. Beginning on the right lead, complete three circles to the right. the first two circles large and fast; the third circle small and slow. Change leads at the center of the arena.

5. Complete three circles to the left: the first circle small and slow; the next two circles large and fast. Change leads at the center of the arena.

6. Begin a large fast circle to the right but do not close this circle. Run down the right side of the arena past the center marker and do a left rollback at least twenty feet from the wall or fence - no hesitation.

7. Continue back around the previous circle but do not close this circle. Run down the left side of the arena past the center marker and do a right rollback at least twenty feet from the wall or fence - no hesitation.

8. Continue back around previous circle but do not close this circle. Run down right side of the arena past the center marker and do a sliding stop at least twenty feet from the wall or fence. Hesitate to demonstrate completion of the pattern.

Rider may be asked to dismount and drop bridle to the designated judge.

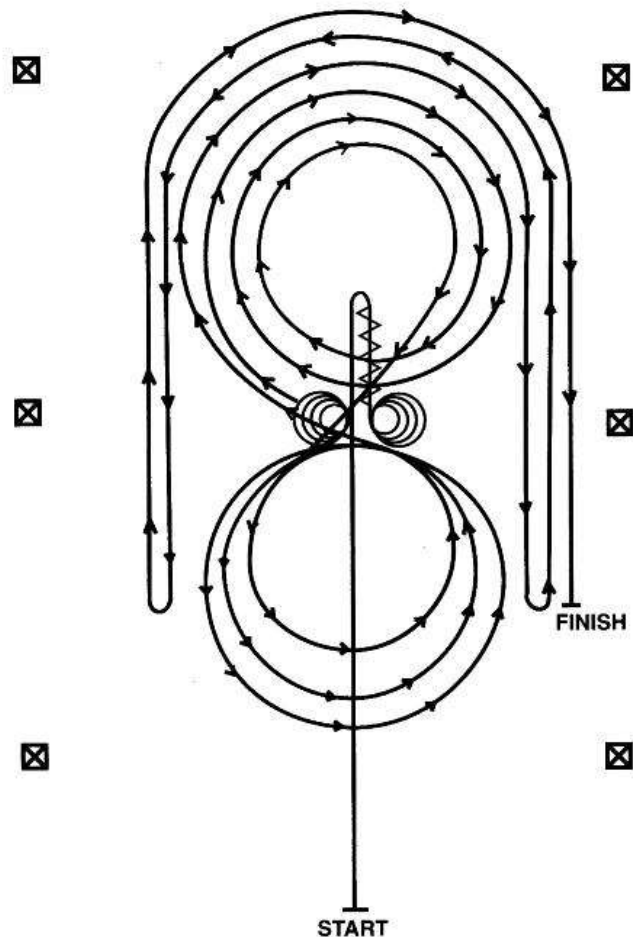

Pattern 11

Horses must jog to the center of the arena.
Horses must walk or stop prior to starting the pattern. Beginning at the center of the arena facing the left wall or fence.

1. Complete four spins to the left. Hesitate.
2. Complete four spins to the right. Hesitate.
3. Beginning on the right lead complete three circles to the right, the first circle small and slow; the next two circles large and fast. Change leads at the center of the arena.
4. Complete three circles to the left; the first circle small and slow; the next two circles large and fast. Change leads at the center of the arena.
5. Begin a large circle to the right, but do not close this circle. Run down the center of the arena past the end marker and do a right rollback—no hesitation.
6. Run up the middle to the opposite end of the arena past the end marker and do a left rollback—no hesitation.
7. Run past the center marker and do a sliding stop. Back up to the center of the arena or at least ten feet. Hesitate to demonstrate completion of the pattern.

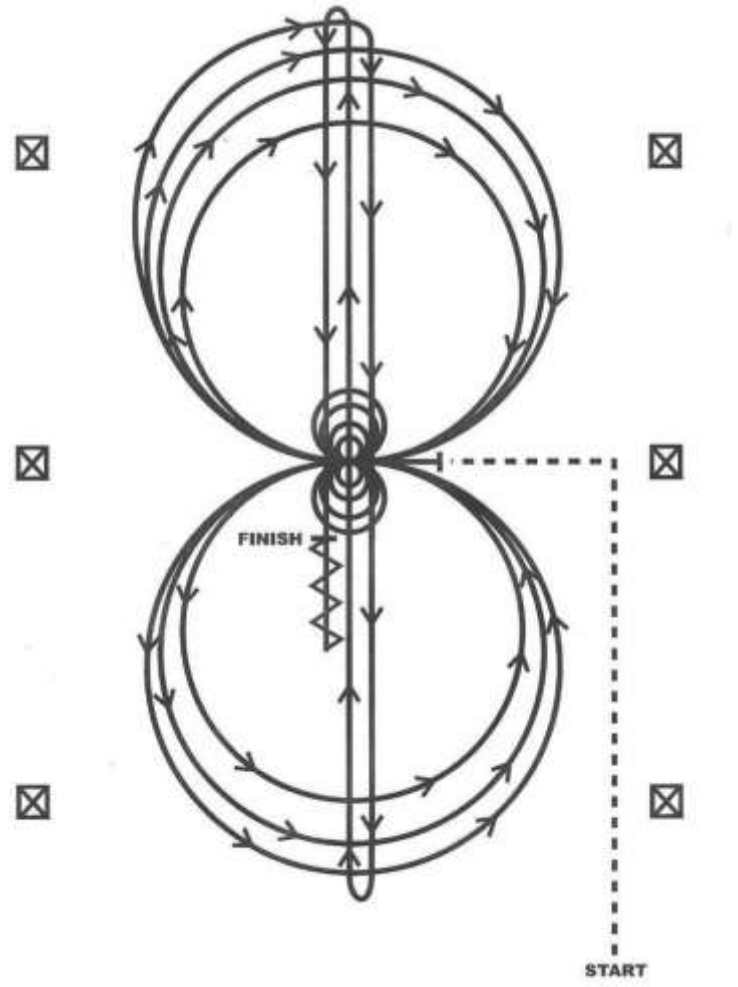

Rider may be asked to dismount and drop bridle to the designated judge.

Pattern 12

1. Run past the center marker and do a sliding stop. Back up to the center of the arena or at least 10 feet. Hesitate.
2. Complete four spins to the right. Hesitate.
3. Complete four and one-quarter spins to the left so that the horse is facing the left wall or fence. Hesitate.
4. Beginning on the left lead, complete three circles to the left; the first two circles large and fast; the third circle small and slow. Change leads at the center of the arena.
5. Complete three circles to the right; the first two circles large and fast; the third circle small and slow. Change leads at the center of the arena.
6. Begin a large circle to the left but do not close this circle. Run up the right side of the arena past the center marker and do a right rollback at least 20 feet from the wall or fence—no hesitation.
7. Continue back around previous circle but do not close this circle. Run up the left side of the arena and past the center marker and do a left rollback at least 20 feet from the wall or fence—no hesitation.
8. Continue back around previous circle but do not close this circle. Run up the right side of the arena past the center marker and do a sliding stop at least 20 feet from the wall or fence. Hesitate to demonstrate completion of pattern.

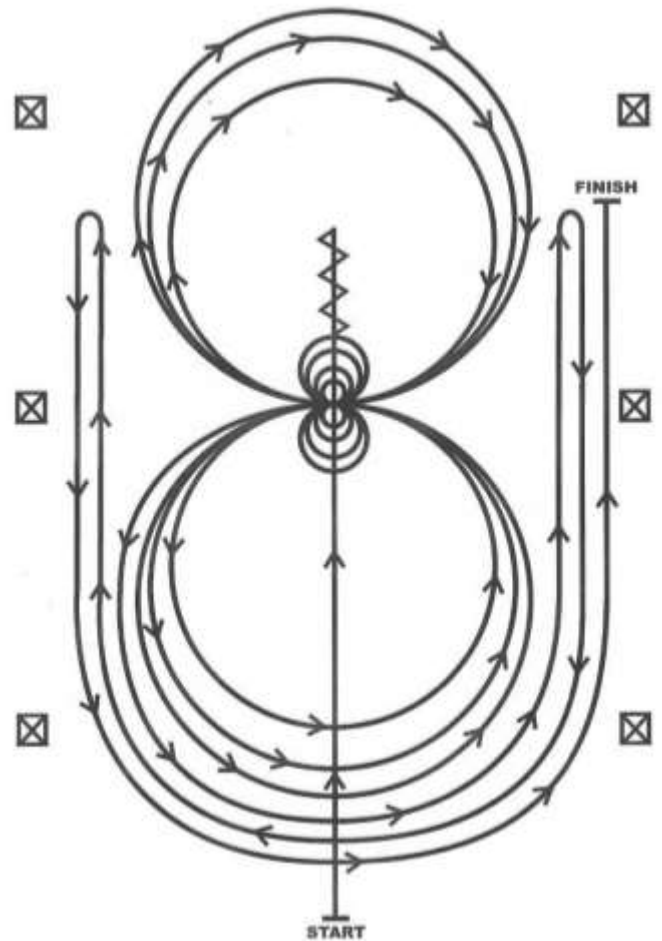

Rider may be asked to dismount and drop bridle to the designated judge.

Pattern 13

Horses must walk or stop prior to starting pattern. Beginning at the center of the arena facing the left wall or fence.

1. Beginning on the left lead, complete two circles to the left: the first circle large and fast; the second circle small and slow. Stop at the center of the arena.
2. Complete four spins to the left. Hesitate.
3. Beginning on the right lead, complete two circles to the right: the first circle being large and fast; the second circle small and slow. Stop at the center of the arena.
4. Complete four spins to the right. Hesitate.
5. Beginning on the left lead, run a large fast circle to the left, change leads at the center of the arena, run a large fast circle to the right, and change leads at the center of the arena.

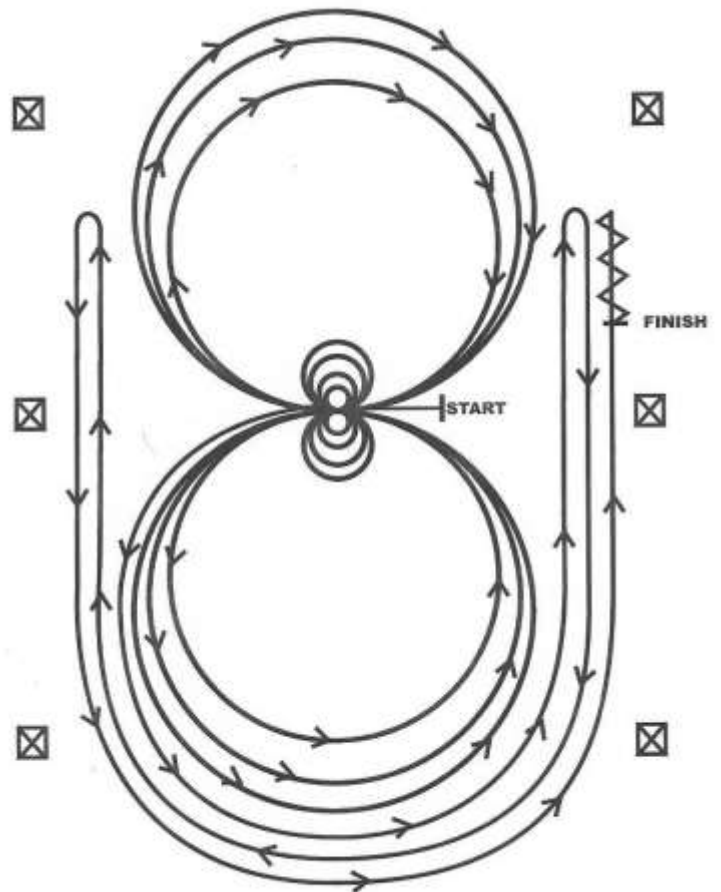

6. Continue around previous circle to the left but do not close this circle. Run up the right side of the arena past the center marker and do a right rollback at least 20 feet from the wall or fence—no hesitation.
7. Continue around previous circle but do not close this circle. Run up the left side of the arena past the center marker and do a left rollback at least 20 feet from the wall or fence—no hesitation.
8. Continue back around previous circle but do not close this circle. Run up the right side of the arena past the center marker and do a sliding stop at least 20 feet from the wall or fence. Back up at least 10 feet. Hesitate to demonstrate completion of pattern.

Rider may be asked to dismount and drop bridle to the designated judge.

SCORING RUBRIC

SCORING:

Scoring will be on the basis of 0-Infinity, with 70 denoting an average performance. The individual maneuvers are scored in 1/2-point increments from a low of -1 1/2 to a high of +1 1/2 with a score of 0 denoting a maneuver that is correct with no degree of difficulty.

PENALTIES

NO SCORE (DISQUALIFICATION):

- Abuse of an animal in the show arena and/or evidence that an act of abuse has occurred prior to or during the exhibition of a horse in competition;
- Use of illegal equipment, including wire on bits, bosals, or curb chains;
- Use of illegal bits, bosals, or curb chains; when using a snaffle bit, optional curb strap is acceptable; however, curb chains are not acceptable.
- Use of tack collars, tie downs, or nose bands;
- Use of whips or bats;
- Use of any attachment which alters the movement of or circulation to the tail;
- Failure to provide horse and equipment to the appropriate judge for inspection;
- Disrespect or misconduct by the exhibitor;
- Closed reins are not allowed except as standard romal reins.
- Excess rein may be straightened at any place a horse is allowed to be completely stopped during a pattern; rider's free hand may be used to hold romal in the normal fashion.

0 SCORE:

- Use of more than index or first finger between reins;
- Use of two hands (exception in Junior, Snaffle Bit, or Hackamore classes designated for two hands) or changing hands;
- Use of romal other than as outlined in “*Rules for Western Pleasure Classes*”. During reining, the use of the free hand while holding the romal to alter the tension or length of the reins from the bridle to the reining hand is considered to be the use of two hands, with the exception of any place a horse is allowed to be completely stopped during a pattern.
- Failure to complete pattern as written:
- Performing the maneuvers other than in specified order;
- The inclusion of maneuvers not specified, including, but not limited to
- Backing more than 2 strides (4 steps = 2 strides – count the FRONT steps)
- Turning more than 90 degrees
- Equipment failure that delays completion of pattern; including dropping a rein that contacts the ground while horse is in motion.
- Balking or refusal of command where performance is delayed;
- Running away or failing to guide where it becomes impossible to discern whether the entry is on pattern;
- Jogging in excess of one-half circle or one-half the length of the arena;
- Overspins of more than 1/4 turn;
- Fall to the ground by horse or rider

Neither a no score nor a 0 are eligible to place in a go round or class, but a 0 may advance in a multi-go event while a no score may not.

FIVE POINTS:

- Spurring in front of cinch;
- Use of either hand to instill fear or praise;
- Holding saddle with either hand;
- Blatant disobediences including kicking, biting, bucking, rearing and striking.

TWO POINTS:

- Break of gait;
- Freeze up in spins or rollbacks;
- On walk-in patterns, failure to stop or walk before executing a canter departure.
- On run-in patterns, failure to be in a canter prior to the first marker.
- If a horse does not completely pass the specified marker before initiating a stop position.

STARTING OR PERFORMING CIRCLES OR EIGHTS OUT OF LEAD WILL BE JUDGED AS FOLLOWS:

- Each time a horse is out of lead, a judge is required to deduct one point. The penalty for being out of lead is accumulative and the judge will deduct one penalty point for each quarter of the circumference of a circle or any part thereof that a horse is out of lead. A judge is required to penalize a horse one-half point for a delayed change of lead by one stride where the lead change is required by the pattern description.
- Deduct 1/2 point for starting circle at a jog or exiting rollbacks at a jog up to two strides (4 steps = 2 strides – count the FRONT steps). Jogging beyond two strides, but less than 1/2 circle or 1/2 the length of the arena, deduct two points.
- Deduct 1/2 point for over or under spinning up to one-eighth (1/8) of a turn; deduct one (1) point for over or under spinning from one-eighth to one-fourth (1/8 to 1/4) turn.
- A 1/2 point penalty deduction will be given for failure to remain a minimum of 20 feet from the wall or fence when approaching a stop and/or rollback.

In patterns requiring a run-around, failure to be on the correct lead when rounding the end of the arena will be penalized as follows: for 1/2 the turn or less, one (1) point; for more than 1/2 turn, two (2) points.

FAULTS AGAINST THE HORSE TO BE SCORED ACCORDINGLY, BUT NOT TO CAUSE DISQUALIFICATION:

- Opening mouth excessively when wearing bit;
- Excessive jawing, opening mouth or head raising on stop;
- Lack of smooth, straight stop on haunches-bouncing or sideways stop;
- Refusing to change leads;
- Anticipating signals;
- Stumbling;
- Backing sideways;
- Knocking over markers.

FAULTS AGAINST THE RIDER TO BE SCORED ACCORDINGLY, BUT NOT TO CAUSE DISQUALIFICATION:

- Losing stirrup;
- Failure to run circles or figure eights within the markers is not considered a fault depending on arena conditions and size; however, failure to go beyond markers on rollbacks and stops is considered a fault.

REINER RAIL

The Reiner Rail class will be conducted immediately following the last reining pattern class.

1. To participate in Reiner Rail, the horse must have completed the pattern in one of the prior reining classes. Zero score pattern runs qualify a horse to enter Reiner Rail. In the gate/out of the gate pattern class entries DO NOT qualify a horse to compete in Reiner Rail.
2. There is only one Reiner Rail class. All qualifying participants will show together.
3. Reiner Rail should showcase the horse's ability to move at a working speed with a rider. Horses will be shown at three gaits - walk, jog or second gait, and lope in each direction of the arena. All gaits should be free flowing and natural. Gaits may be extended at the judge's discretion. Judges must consider all gaits equally in adjudicating this class.
 - a. **Walk**, a four-beat gait: true, flat-footed, and ground covering.
 - b. **First Gait**, See *Rules for Western Pleasure*.
 - c. **Jog**, a two-beat diagonal gait: free, square, smooth, controlled, and forward moving.
 - d. **Second Gait**. See *Rules for Western Pleasure*.
 - e. **Lope**, a true three-beat gait: smooth, controlled, willfully guided, and straight on both leads. It should be rated while demonstrating forward motion.
 - f. **Back**, two beat gait: straight and true.
 - g. All gaits may be extended at the judge's discretion.
4. Competitors enter the ring in a counterclockwise direction.

5. Light contact with the horse's mouth must be maintained at all gaits.
6. Horses should at all times be willfully guided, showing little or no resistance when asked for all tasks, including extending gaits.
7. Horses will be asked to reverse directions at either the walk or jog (or second gait) while on the rail, never at the lope. Also on the rail, horse will be asked to stop and back. The stop should be immediate and quiet. The back should be straight and true. The horse will be penalized for gaping of mouth during stopping or backing.
8. A horse will be given credit for traveling with head carriage in a natural position; ears alert, and moving at a natural speed for the gait requested. A horse will be given credit for demonstrating athleticism, smoothness, and finesse while performing all gaits. Credit also will be given for making a smooth transition between the gaits, for keeping the correct lead, and for maintaining the gait until the judge asks for a change.
9. A horse will be heavily penalized for: artificial appearance of frame or gait, extremely low head carriage, excessively slow and/or a four beat way of travel in the lope, and any display of resistance. While moving down the rail, the horse's body should be straight.
10. If bridles are to be checked, it is the sole decision of the judge to do so. Riders must dismount.
11. Boots and/or bandages are not permitted. Exceptions can be made for inclement weather or conditions. In the event of an injury, the judge may permit a protective bandage.
12. Horses shall not be shown with artificial appliances that would tend to alter their performance.

Class specifications: See "*ISHSA Approved Class List*".

Class default rule book: For situations that are not covered by the ISHSA rule book, ISHSA will default to the AQHA rule book for reining classes. To stay compliant with changes in the equine industry, ISHSA will add or subtract patterns and or scoring rules for reining immediately following the lead of such changes made by AQHA. ISHSA will follow suit without needing to specifically vote on the changes.

It is suggested that judge(s) post their score sheets following the completion of the class(es).

Patterns and score sheets are available on the AQHA website.

RULES FOR GYMKHANA CLASSES

General:

1. Points are accumulated by the horse and not by the exhibitor.
2. Unsoundness shall not be penalized in an entry unless it is sufficiently severe to be considered inhumane treatment. In such a case, management shall bar the entry from further participation.
3. Poles (stakes) shall be approximately 1½ inch in diameter and of a safe material that will not splinter. Each shall be from 6' to 7' feet high, with a safe stable stand for the ballast. Each shall be painted so that it is easily distinguished from the background. Official base should be 12" to 14" in diameter.
4. Barrels shall be of the size of a fifty-five-gallon metal drum and shall contain no sharp edges, either on the inside or the outside. Each shall be painted so that they are easily distinguished from the background. A protective device around the top of the barrels is permitted.
5. Management shall designate the order in which the entries shall compete. No more than one entry shall be in the ring at one time.
6. Riders must be mounted before entering the arena. An exhibitor shall be considered "on course" once any part of the horse crosses the starting line, and until every part of the horse crosses the finish line after completing the course.
7. Timing Line—The course for all competitors shall include a timing line to be a distance of at least 20' from the first obstacle. The timing line is imaginary and should be indicated by stakes, pylons, or other suitable markers.
8. Start and Finish—The exhibitor shall be signaled when the judge and timing officials are ready. At any time within one minute after the ready signal is given, the entry shall cross the timing line and begin the course. Starting and finishing time shall be taken the instant any part of the entry crosses the timing line. Running start is prohibited. The gate will close once the horse is in the arena. The gate must remain closed and the horse come to a halt or walk inside the arena before the gate is again opened.
9. Ties to be broken with a runoff, or by flip of coin if agreed to by contestants.
10. Electronic timing equipment is preferred or, if not available, two stopwatches must be used, with one being the official time and the other as a backup.
11. All times and/or disqualifications shall be announced over the P.A. or loudspeaker immediately following each individual run.
12. Breakage—If tack or equipment should break or the animal should cast a shoe while negotiating the course, should the entry be able to continue the course despite the difficulty and without cruelty, it may continue without penalty.
13. All measurements given in the gymkhana rules are desired if arena space allows. When space does not allow prescribed measurements, show management can make adjustments to prescribed measurements so long as the integrity of the course is not altered.

Disqualification:

1. Failure to begin course within one (1) minute after ready signal.
2. Any deviation from the pattern.

3. Fall of horse and /or exhibitor while on course.
4. Spurring the horse, use of crop, bat, or romal in any manner whatsoever forward of the front cinch, after entering the arena.
5. Entry being unruly or out of control.
6. Any kind of inhumane treatment whether or not specifically mentioned in this rule
7. Excessive use of spurs, crop, bat, or romal.
8. Failure of entry to leave the ring immediately upon notification by the judge of disqualification shall bar both the horse and exhibitor from further participation in the show.
9. Breakage—If tack or equipment should break or the animal should cast a shoe while negotiating the course, and the difficulty prevents completion of the course.
10. On walk/trot courses, loping more than three (3) consecutive strides.
11. Crossing over the timing line after the start, but before the pattern is completed.

Penalties:

1. A five-second (5) penalty shall be assessed for each obstacle knocked down unless otherwise provided in the class specification. The exhibitor must remain on course as if the obstacle were still standing.
2. If hat or safety helmet is worn and it falls off and touches the ground while in the arena, a five-second (5) penalty will be assessed.
3. On walk/trot courses, each break to a lope which is less than three (3) strides shall result in a five-second (5) penalty.

Appointments:

Equipment (saddle) and attire must be western.

1. All western (stock) tack and equipment is acceptable if humane. Refer to *“Rules for Western Pleasure Classes” – “Appointments”* for proper western attire.
2. If a tiedown or cavesson is used, the noseband must be rope, leather, or nylon. No wire is permitted.
3. Hats or safety helmets are recommended for all gymkhana classes, but are at the exhibitor’s option.
4. Protective headgear may be worn without penalty.
5. The type of bridle and/or bit is optional including English bridles and bits. Snaffles, bosals, hackamores, bitless bridles, etc. may be worn.
6. Excessively severe bits, unusual construction or arrangements of equipment, if considered by the judge to be inhumane, abnormal, or dangerous may be prohibited at the judge’s discretion.
7. The method of holding reins is optional.
8. Tie downs, skid boots, splint boots, bell boots, whips, bats and/or quirts may be used as optional equipment as long as they are used in a humane manner.
9. Tack collars are prohibited.

Events:

Barrel Racing:

Completion patterns

- 1) The rider shall have two (2) options
 - a) Cross the timing line, circle barrel one (1) counter-clockwise, circle barrel two (2) clockwise, circle barrel three (3) clockwise, and cross timing line. Shown in the diagram below.
 - b) Cross the timing line, circle barrel two (2) clockwise, circle barrel one (1) counter-clockwise, circle barrel three (3) counter-clockwise and cross timing line. Not shown in the diagram below.

Course

- 2) Three barrels shall be placed to form an isosceles triangle. The distance from barrel 1 to barrel 2 shall be 105'. The distance from barrel 1 to barrel 3 shall be 120'. The distance from barrel 2 to barrel 3 shall be 120'. The distance from barrels 1 and 2 to the timing line shall be 75'
- 3) A contestant may touch the barrel with his/her hands.

Barrel racing diagram:

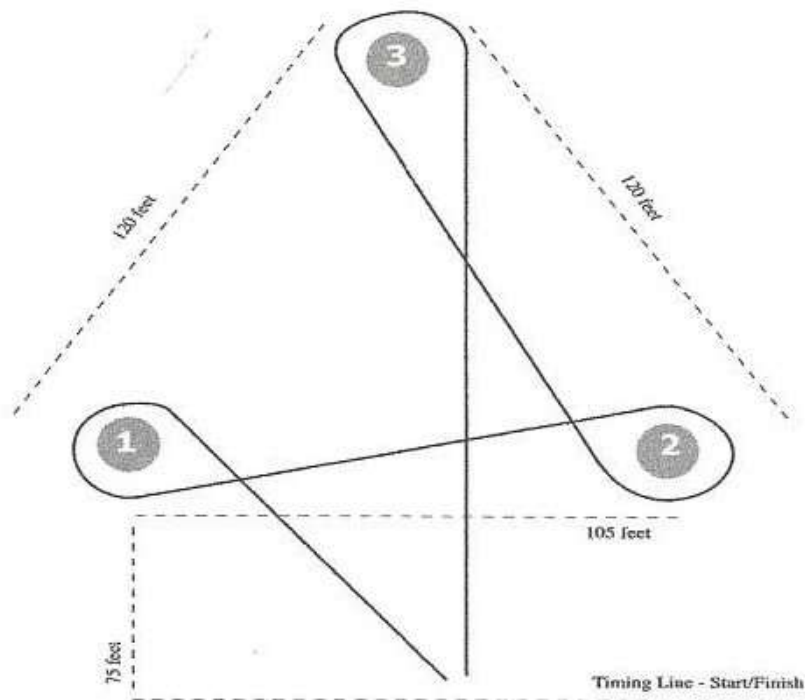

Flag Race:

1. Management should allow ample room between the barrels and any side fences.
Measurements are made to the center of the base of the barrel. A bucket or similar container $\frac{3}{4}$ full of sand or other suitable material, shall be placed on the barrels as a depository for the 18" flags.
2. The rider shall have the option of riding the pattern, either to the left or right, after crossing the timing line.
3. Course—three barrels shall be placed to form an isosceles triangle. The distances shall conform to the barrel racing pattern.
4. Penalties—knocking over the bucket holding the flags without knocking it off the barrel incurs a five-second (5) penalty.
5. Causes for disqualification.
 - a. Failure to pick up the flag on the first pass.
 - b. Failure to place the flag in the bucket on the first pass.
 - c. Touching any part of the horse's body with the flag or stick.
 - d. Dropping the flag.
 - e. Knocking over any of the barrels, or knocking the bucket off the barrel.

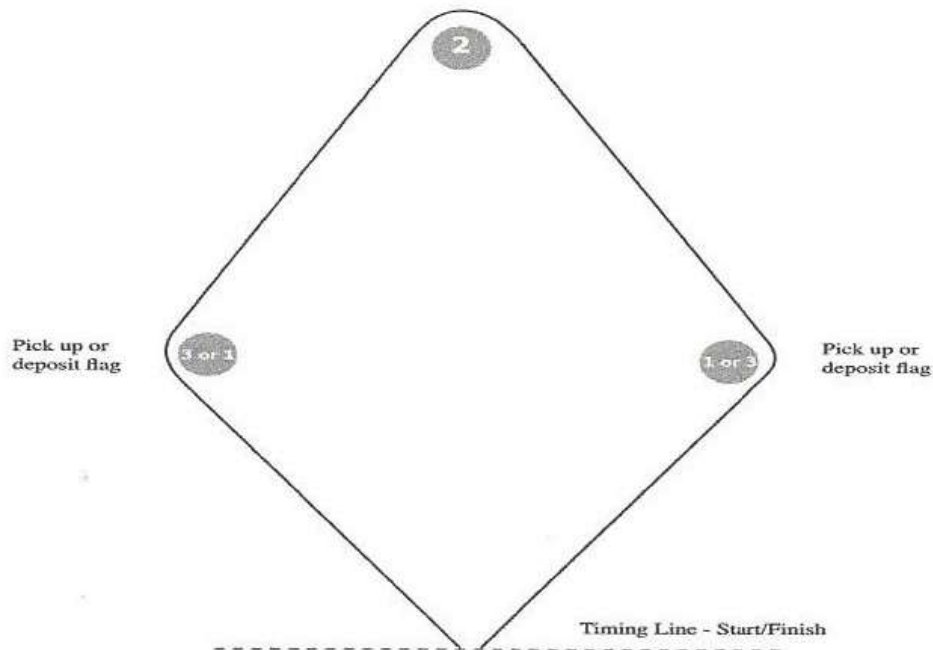

Pole Bending:

1. The rider shall have his/her choice of the side on which to pass the first pole.
Management should allow ample room between all running lanes and between the lanes and walls or fences.
2. Six (6) poles shall be placed 21' apart in a straight line down the approximate center of the ring, with the first pole being 21' from the timing line. The timing line shall be 30' long. The entry shall cross the timing line, move in an approximately straight line to pole 6 (farthest pole), make a 180° turn around pole 6, pass between pole 6 and pole 5, bend through the poles to pole 1, circle pole 1, bend through the poles to pole 6, make a 180° turn around pole 6, and cross the timing line, by moving along the poles on the side opposite that on which it first approached pole 6.
2. Contestant may touch the poles with his/her hands.

Pole bending diagram:

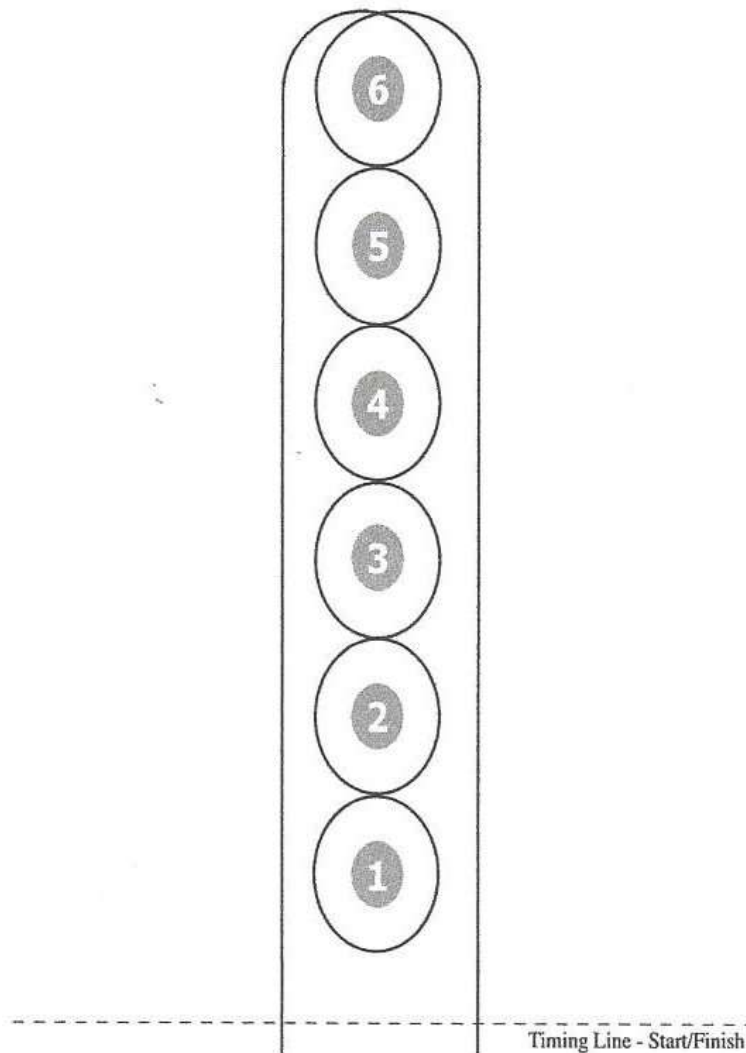

Key Race

1. Four poles are placed 5 feet apart at marks 110 and 120 feet from the start/finish line.
The rider travels between the poles completely, reverses course, and travels back through the poles and back to the finish line.
2. A ten-second (10) penalty shall be assessed for each pole knocked down.

Key Race diagram:

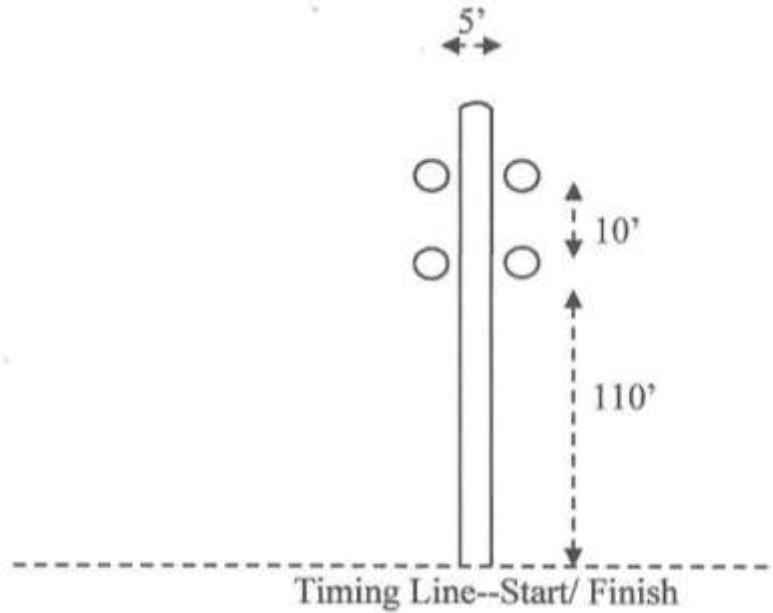
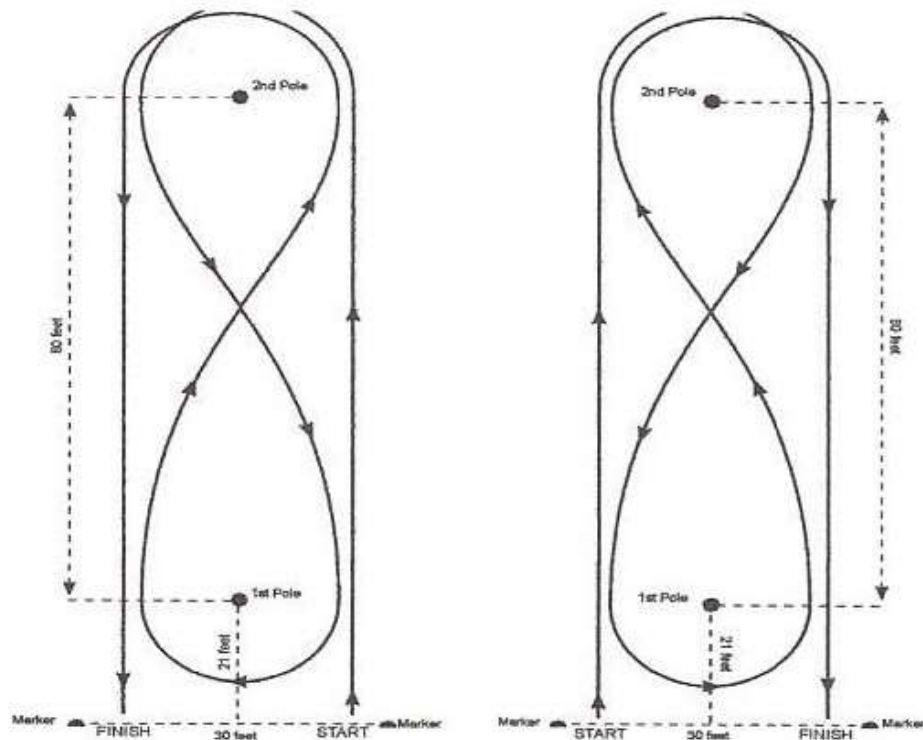

Figure 8 Stake Race:

1. The start/finish line is thirty (30) feet wide and marked by two (2) upright markers (cones or pylons)
2. There are two (2) stakes in this event. The stakes shall be eighty (80) feet apart. The first stake shall be twenty-one (21) feet from the start/finish line if arena size permits. The pattern maybe shortened depending upon arena size; however, the two (2) stakes must always be placed eighty (80) feet apart regardless of the distance between the first stake and the start/finish line.
3. Exhibitor shall cross the start/finish line and run down the right or left side of the poles to the second pole making either a right or left-hand turn. Exhibitor shall then run to the first pole and make a turn in the opposite direction. Exhibitors must then run back to the second pole and repeat first turn then run straight back down either the left or right side of the poles (opposite side than when first crossing start line and running to the second pole) and cross the start/finish line. Patten must be run according to diagram in ISHSA rule book.
4. Disqualification will occur if either of the upright poles or either of the two (2) upright markers are knocked down.

Stake race diagram:



Class specifications: See “*ISHSA Approved Class List*”.

Class default rule book: For situations that are not covered by the ISHSA rule book, ISHSA will default to the PtHA rule book for gymkhana classes.

RULES FOR RANCH CLASSES

General:

1. Points are accumulated by the horse and not by the exhibitor.
2. The Ranch Horse classes are designed to show the overall ability of the horse to perform skills necessary to those of the all-around ranch horse. Posting or standing at the extended trot is acceptable in any class. Holding the saddle horn with either hand will not be penalized in any class.
3. An individual or an organization may host a ranch only show without offering any of the other ISHSA classes as long as they have secured an approved date, paid their sanction fee, hired an approved judge, offer all five (5) ranch class divisions, and follow the ISHSA rule book as applicable.
4. Exhibitors are encouraged to enter ranch classes and non-ranch classes; therefore, some industry standard ranch rules will be suspended for ISHSA sanctioned shows. For example, cross entering is not forbidden; hoof polish, braided/banded manes, and artificial hair extensions are discouraged in ranch but will not be penalized or be disqualified.
5. For any class that utilizes patterns, *refer to the diagrams*. The patterns are to be worked as stated, not as drawn. The drawn patterns are just to give the general idea of what the patterns will look like in the arena.
6. All judges' decisions are final.

Appointments

1. Appropriate western attire is required, which includes pants (ankle length or longer slacks, trousers, jeans, etc.); shirt, blouse or jacket with long sleeves and a collar (band, standup, tuxedo, etc.). A vest accompanied with a long-sleeve shirt or blouse with a collar, and/or a jacket with a shirt that has a collar, is acceptable. A western hat and cowboy boots are also required. The use of spurs, chaps, belts, and hard hats are optional.
2. Any exhibitor may wear protective headgear in any division or class without penalty from the judge. ISHSA strongly encourages all riders to wear protective headgear passing or surpassing current applicable ASTM (American Society for Testing and Materials)/SEI (Safety Equipment Institute) standards with harness secured while riding anywhere on the competition grounds.
3. Western type equipment must be used. Horses shall be shown with a stock saddle. Equipment with silver should not count over a good working outfit. Silver equipment is discouraged but not prohibited. Bridle may be either a standard plain or silver headstall with a brow band, shaped ear, or split ear.
4. It is suggested that competitors use a breast collar and rear cinch.
5. Hoof polish is discouraged but will not be penalized.
6. Braided/banded manes are discouraged along with artificial hair extensions.
7. Trimming inside ears is discouraged.
8. Trimming bridle path is allowed, also trimming of fetlocks or excessive (long) facial hair.
9. Horses, of all ages, may be shown in a snaffle, bosal, or curb bit. When a bit is used, the mouthpiece must be at least 5/16" and not more than 3/4" in diameter measured one

inch from cheek and must be smooth. Shanks may be fixed or loose. Nothing may protrude below the mouthpiece such as extensions or prongs. A standard western curb bit must not be longer than 8 ½ inches measured on the outside length from the top bridle attachment to the rein attachment. The port must not be higher than 3 ½ inches with rollers and covers acceptable. Broken mouthpieces, half breeds and spades are standard. Split reins shall be used with all bits except that a romal is acceptable with a curb bit. Closed reins are not allowed except as standard romal reins or standard mecate reins which include a tie rope with snaffle bit or bosal. Curb straps are required for curb bits and the curb chains or straps must be at least ½ inch in width and must lie flat against the horse's chin.

10. Romal reins are allowed in all Ranch Horse classes. When riding with a romal, a get down rope may be used. A get down rope is defined as a small rope tied around the neck of the horse with a bowline or other non-slip knot and run back to the rider or tied to the saddle. The get down will be used to lead, ground tie, or tie the horse.
11. The use of two-rein equipment is allowed in all Ranch Classes. All rules for 2-rein will follow hackamore and bridle requirements.
12. No wire curbs are permitted, regardless of the amount of padding or tape. Absolutely no iron will be permitted under the jaws. Prohibited equipment includes tie downs, cavessons, gag bits, mechanical hackamores, and running martingales.
13. The judge may prohibit the use of bits and equipment he/she may consider too severe.
14. A bit cannot be physically or mechanically changed to increase the severity of its use and may be eliminated at the discretion of the judge.
15. Optional Equipment: Leg wraps and/or boots, the carrying of a rope or reata, spurs, chaps, or chinks.

RANCH HORSE GAITS

The following terminology shall apply whenever a specific gait is called for in the Ranch events.

1. **WALK:** The walk is a natural, flat footed, four-beat gait. The gait is rhythmic and ground-covering. As in all gaits, the horse should display a level, or slightly above level topline with a bright, attentive expression.
2. **TROT:** The trot is a natural two-beat gait demonstrating more forward motion than the western jog.
3. **EXTENDED TROT:** The extended trot is an obvious lengthening of the stride with a definite increase in pace. The horse should be moving in a manner as if it were covering a large area on a ranch with an above level topline.
4. **LOPE:** The lope is a three-beat gait. The lope should be relaxed and smooth with a natural, forward moving stride.
5. **EXTENDED LOPE:** The extended lope is not a run or a race but should be an obvious lengthening of the stride, demonstrating a forward, working speed. The horse should display an above level topline with a bright, attentive expression.
6. **BACK:** The horse should back straight at least one-horse length quietly and without gapping his mouth. This should be done smoothly with light contact and without hesitation.
7. Horses must be sound of limb.

Class specifications: See *“ISHSA Approved Class List”*.

Class default rule book: For situations that are not covered by the ISHSA rule book, ISHSA will default to the AQHA rule book for ranch classes. To stay compliant with changes in the equine industry, ISHSA will add or subtract patterns and or scoring rules for ranch immediately following the lead of such changes made by AQHA. ISHSA will follow suit without needing to specifically vote on the changes.

It is suggested that judge(s) post their score sheets following the completion of the class(es).

Patterns and score sheets are available on the AQHA website.

RANCH TRAIL

This class should test the horse's ability to cope with situations encountered while being ridden through a pattern of obstacles generally found during the course of everyday ranch work. The horse/rider team is judged on the correctness, efficiency, and pattern accuracy with which the obstacles are negotiated, and the attitude and mannerisms exhibited by the horse. Judging emphasis is on identifying the well broke, responsive, and well-mannered horse which can correctly navigate and negotiate the course. The ideal ranch trail horse should have a natural ranch horse appearance from head to tail in each maneuver.

1. The ranch trail course will include no less than six and no more than nine obstacles. It is mandatory that the horse be asked to walk, trot, and lope during the course. Walk can be part of obstacle score or be scored with the approaching obstacle. Trot must be at least 35 feet and score with approaching obstacle. Lope must be lead specific, at least 50 feet and score with approaching obstacle. Care must be exercised to avoid setting up any obstacles that may be hazardous to the horse or rider.
2. The competition trail course must be posted at least one hour prior to competition. Printed handouts for exhibitors are helpful and encouraged.
3. When setting courses, management will be mindful that the idea is not to trap a horse/rider team or eliminate it by making an obstacle too difficult. All courses and obstacles are to be constructed with safety in mind to reduce the risk for accidents. Show committee shall have the option of setting up the trail course to best fit the arena conditions. An outdoor course is recommended if appropriate terrain is available. The use of natural obstacles is also encouraged. Each single performance event can be time consuming, especially with large classes. The show committee, either through a pilot run or estimation, shall select a course that has a continuous and positive flow that can be negotiated in four minutes or less.
4. Judges must walk the course and have the right and duty to alter the course if it is not in keeping with the intent of the class. Judges may remove or change any obstacles they deem unsafe, non-negotiable, or unnecessarily difficult. Any time a trail obstacle becomes unsafe during a class, it shall be repaired or removed from the course. If the course cannot be repaired and some horses have completed the course, the score for that obstacle shall be deducted from all previous draws in that class.
5. The course must be designed using the mandatory obstacles and maneuvers plus optional obstacles. Any and all obstacles requiring mount and or dismount, will require management to provide stool/mounting block.
6. Combining two or more of the obstacles is acceptable.

PROHIBITED OBSTACLES: Tarps, water obstacles with slick bottoms, PVC pipe used as a jump or walk over, tires, rocking or moving bridges, logs elevated in a manner that permits such to roll in a dangerous manner.

MANDATORY OBSTACLES AND/OR MANEUVERS:

1. Ride over obstacles on the ground – usually logs or poles. Walk, trot, or lope may be used, but only one gait is required.
 - a. Walk-overs: Walk over no more than five logs or poles no more than 10 inches high. The space between logs or poles should be 26 to 30 inches. The formation may be straight, curved, zigzagged, or raised.
 - b. Trot-overs: Trot over no more than five logs or poles no more than 10 inches high. The space between logs or poles should be 36 to 42 inches. The formation can also be straight, curved, zigzagged, or raised.
 - c. Lope-overs: Lope over no more than five logs or poles no more than 10 inches high. The space between logs or poles should be 6 to 7 feet. The formation can also be straight, curved, zigzagged, or raised.
2. Opening, passing through, and closing gate: Use a gate that will not endanger horse or rider and requires minimum side passing. It is recommended to use a hinged swinging gate but not required.
3. Ride over wooden bridge: Bridge should be sturdy, safe, and negotiated at a walk only. Heavy plywood lying flat on the ground is an acceptable simulation of a bridge. Suggested minimum width shall be 36 inches wide and at least 6 feet long.
4. Backing obstacles: Backing obstacles are to be spaced at a minimum of 28 inches. If elevated, 30-inch spacing is required. Back through and around at least three markers. Back through L, V, U, straight or similarly shaped course which may be elevated no more than 24 inches.
5. Side pass obstacle: Any object which is safe and of any length may be used to demonstrate responsiveness of the horse to leg signals. Raised side pass obstacles should not exceed 12 inches.
6. Rope drag: Drag may be a complete figure eight and may begin in either direction. The exhibitor must have the rope dallied on the saddle horn (a full dally) for the duration of the drag.

OPTIONAL OBSTACLES: Optional obstacles may be used provided the obstacles can be found in everyday ranch work. Optional obstacles from which selections can be made include but are not limited to:

1. A jump obstacle whose center height is not less than 14 inches high or more than 25 inches high. Holding the saddle horn is permissible for this obstacle.
2. Carry object from one part of the arena to another.
3. Remove and replace materials from a mailbox.
4. Trot through cones spaced a minimum of 6 feet apart.
5. Cross natural ditches or ride up embankments.
6. Swing rope or throw rope at a dummy steer head.
7. Step in and out of obstacle.
8. Put on slicker or coat.
9. Stand to mount with mounting block. Stool/Mounting block will be provided.
10. Walk through water obstacle.
11. Open gate on foot. Stool/Mounting block will be provided.
12. Pick up feet.
13. Walk through brush.

14. Ground tie. Stool/Mounting block will be provided.
15. Lead at the trot.

RANCH TRAIL SCORING RUBRIC:

1. All runs begin upon entering the pen and any infractions are subject to penalty at that time (such as two hands on the reins except with a snaffle bit or bosal, using either hand to instill fear or praise, etc.). The rider has the option of eliminating any obstacle, however this will result in being “off pattern” (OP) and the horse/rider team may not place above others who have completed the pattern correctly. A judge may ask a horse to pass on an obstacle after three refusals or at any time for safety concerns.
2. Posting or standing at the extended trot is acceptable.
3. Holding the saddle horn with either hand will not be penalized in any ranch class.
4. Cross entry into regular trail is allowed.
5. Credit is given to horse/rider teams who negotiate the obstacles correctly and efficiently. Horses should receive credit for showing attentiveness to obstacles and ability to negotiate through the course when the obstacles warrant it while willingly responding to rider’s cues on more difficult obstacles. Quality of movement and cadence should be considered part of the maneuver score for the obstacle. The scores should be totaled after each run. It is encouraged that score sheets be posted after each class to allow riders to evaluate their performance. The scoring system is designed to be positive, straightforward, and always encourage growth and improvement in both horse and rider.

The scoring system is designed to give credit for the work done. Each horse/rider team is scored between 0-100 points and automatically begins the run with a score of 70 points. The horse/rider team is scored on the quality of each maneuver (e.g., -1 1/2 extremely poor, -1 very poor, -1/2 poor, 0 correct, +1/2 Good, +1 very good, +1 1/2 excellent). Plusses and minuses are a reflection of the smoothness, finesse, attitude, quickness, and authority of the horse/ rider team when performing the various maneuvers. Penalties may be accrued for incorrect maneuver execution.

PENALTIES

1 Point Penalties:

- over-bridled (per maneuver);
- each hit, bite or stepping on a log, cone, plant or any component of the obstacle;
- incorrect or break of gait at walk or trot for two (2) strides or less;
- both front or hind feet in a single-stride slot or space at a walk or trot;
- skipping over or failing to step into required space;
- split pole in lope-over;
- incorrect number of strides, if specified;
- one to two steps on mount/dismount or ground tie except shifting to balance.

3 Point Penalties:

- wrong lead or out of lead;
- draped reins;
- break of gait at lope;
- break of gait at walk or trot for more than two (2) strides;
- three to four steps on mount/dismount on ground tie.

5 Point Penalties:

- spurring in front of cinch;
- blatant disobedience;
- use of either hand to instill fear/praise;
- knocking over, stepping out of or falling off an obstacle;
- dropping an object required to be carried;
- 1st or 2nd cumulative refusal;
- letting go of gate,
- five or more steps on mount/dismount or ground tie.

Off-Pattern (OP):

Exhibitors cannot place above others who complete pattern correctly.

- Breaking pattern;
- Use of two hands (except in snaffle bit or hackamore);
- more than one finger between split reins or any fingers between romal reins (except two rein);
- 3rd refusal;
- repeated blatant disobedience;
- failure to dally and remain dallied.

Disqualification (DQ):

Disqualified entries are counted as an entry in the class but cannot receive points or credits for that class.

- lameness;
- abuse;
- illegal equipment;
- disrespect or misconduct;
- leaving working area before pattern is complete;
- improper western attire;
- fall of horse/rider (run ends; scores will be given for work done but the horse/rider team will be disqualified and will not be placed).

RANCH RIDING

The purpose of the ranch riding class is to measure the ability of the horse to be a pleasure to ride while being used as a means of conveyance from performing one ranch task to another. The horse should reflect the versatility, attitude and movement of a working ranch horse riding outside the confines of an arena. The horse should be well-trained, relaxed, quiet, soft, and cadenced at all gaits. The ideal ranch horse will travel with forward movement and demonstrate an obvious lengthening of stride at extended gaits. The horse can be ridden with light contact or on a relatively loose rein without requiring undue restraint, but not shown on a full drape of reins. The overall manners and responsiveness of the ranch riding horse to make timely transitions in a smooth and correct manner, as well as the quality of the movement are of primary considerations. The ideal ranch riding horse should have a natural ranch horse appearance from head to tail in each maneuver.

CLASS REQUIREMENTS:

1. The required maneuvers will include the walk, trot, and lope both directions; the extended trot and extended lope at least one direction; as well as stops, and back.
2. Three optional maneuvers may include a side pass, turns of 360 or more, change of lead (simple or flying), walk, trot or lope over a pole(s); or some reasonable combination of maneuvers that would be reasonable for a ranch horse to perform.
3. The maneuvers may be arranged in various combinations with final approval by the judge.
4. The overall cadence and performance of the gaits should be as those described under “Ranch Horse Gaits”, with an emphasis on forward movement, free-flowing, and ground covering for all gaits. Transitions should be performed where designated, with smoothness and responsiveness.
5. No time limit.
6. One of the suggested 15 patterns must be used.
7. The use of natural logs is encouraged.
8. Posting or standing at the extended trot is acceptable
9. Touching or holding the saddle horn is acceptable.

RANCH RIDING SCORING RUBRIC:

Each horse will work individually, performing both required and optional maneuvers, and scored on the basis of 0 to 100, with 70 denoting an average performance. Each maneuver will receive a score that should be added or subtracted from 70 and is subject to a penalty that should be subtracted. Each maneuver will be scored on the following basis, ranging from plus 1 1/2 to minus 1 1/2.: -1 1/2 extremely poor, -1 very poor, -1/2 poor, 0 correct, +1/2 good, + 1 very good, + 1 1/2 excellent. Maneuver scores are to be determined and assessed independently of penalty points.

PENALTIES:

A contestant shall be penalized each time the following occur:

1 Point Penalties:

- Too slow/per gait
- Over-Bridled
- Out of Frame
- Break of gait at walk or jog for 2 strides or less

3 Point Penalties:

- Break of gait at walk or trot for more than 2 strides
- Break of gait at lope, except when correcting an incorrect lead
- Wrong lead or out of lead
- Draped reins
- Severe disturbance of any obstacle
- Out of lead or cross-cantering more than two strides when changing leads, trotting more than three strides when making a simple lead change

5 Point Penalties:

- Blatant disobedience (kick, bite, buck, rear, etc.)
- Each refusal

Off-Pattern (OP):

Placed below horses performing all maneuvers

- Eliminates or adds maneuver
- Incomplete maneuver
- Breaking pattern
- Repeated blatant disobedience
- Use of two hands except with snaffle or hackamore; more than one finger between slip reins or any fingers between romal reins (except in two rein).
- All equipment for Ranch Horse classes applies.

0 Score:

- Illegal equipment
- Willful abuse
- Lameness

RANCH RIDING - PATTERN I

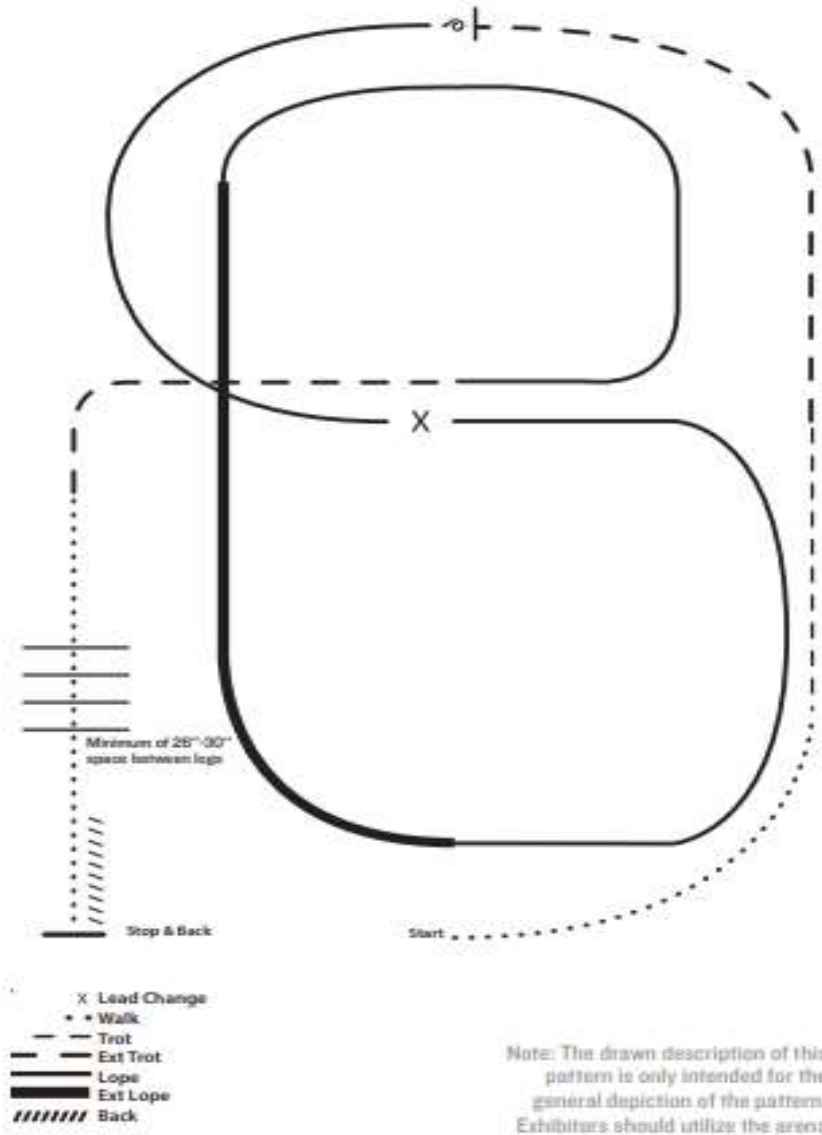

1. Walk
2. Trot
3. Extend the trot, at the top of the arena, stop
4. 360 degree turn to the left
5. Left lead 1/2 circle, lope to the center
6. Change leads (simple or flying)
7. Right lead 1/2 circle
8. Extended lope up the long side of the arena (right lead)
9. Collect back to a lope around the top of the arena and back to center
10. Break down to an extended trot
11. Walk over logs
12. Stop and back

RANCH RIDING - PATTERN I

WALK TROT

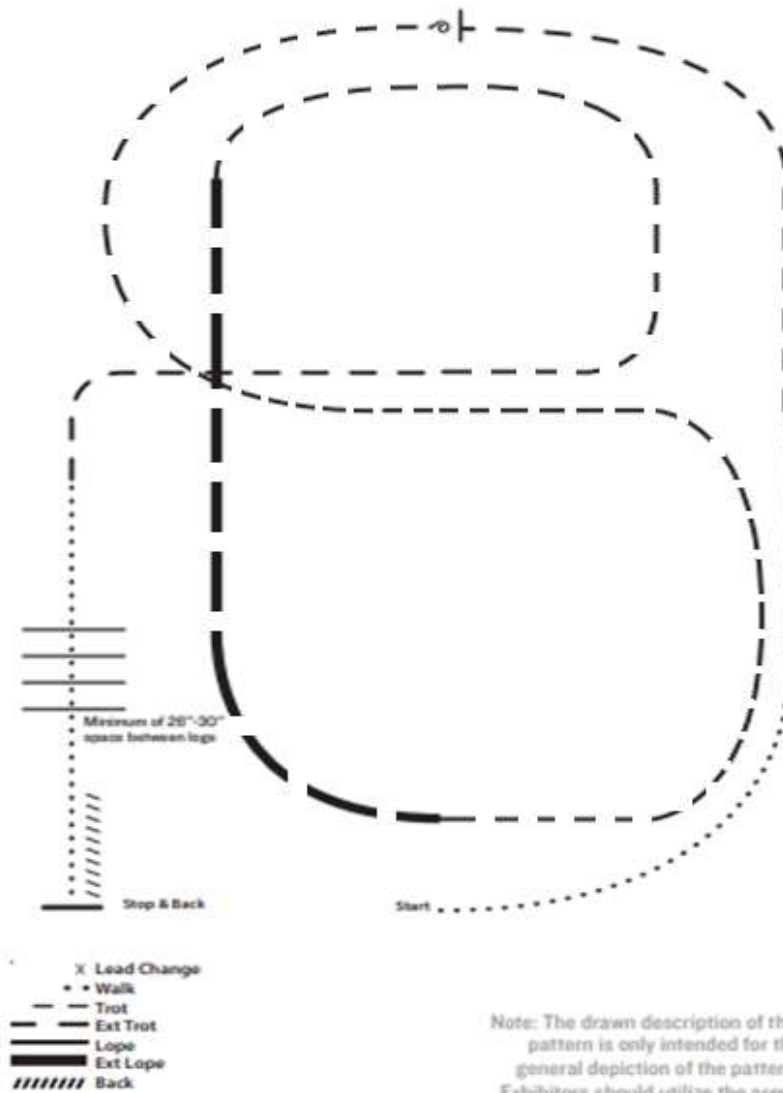

1. Walk
2. Trot
3. At the top of the arena, stop
4. 360 degree turn to the left
5. Trot 1/2 circle to the left
6. Trot 1/2 circle to the right
7. Extended trot up the long side of the arena
8. Collect back to a trot around the top of the arena and back to the long side
9. Break down to walk
10. Walk over logs
11. Stop and back

RANCH RIDING - PATTERN 2

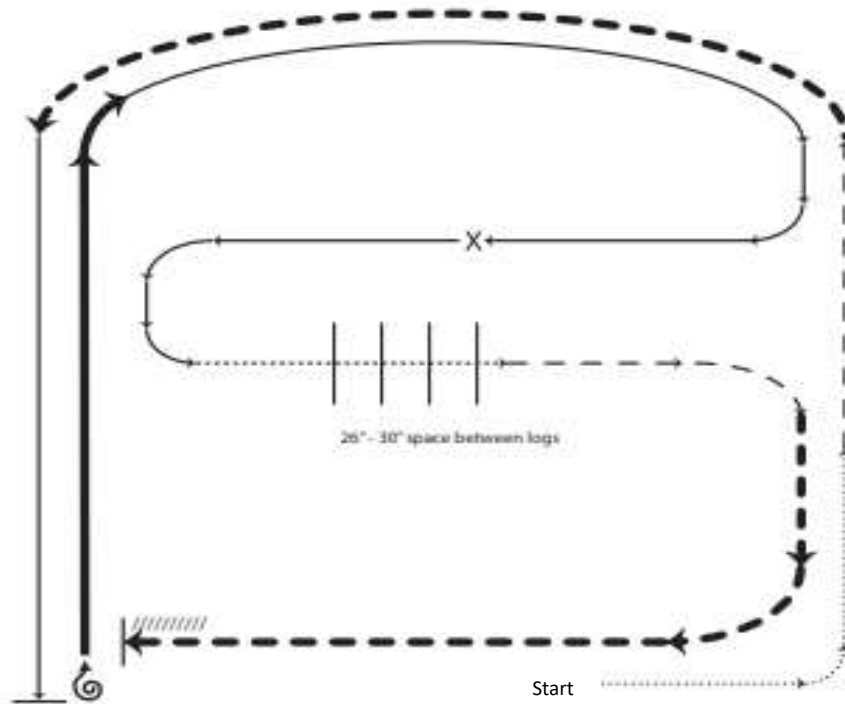

- X Lead Change
- Walk
- - - Trot
- - - - Ext Trot
- ==== Lope
- ==== Ext Lope
- ////// Back

1. Walk
2. Trot
3. Extended trot
4. Left lead lope
5. Stop, 1 1/2 turn right
6. Extended lope
7. Collect to working lope-right lead
8. Change leads (simple or flying)
9. Walk
10. Walk over logs
11. Trot
12. Extended trot
13. Stop and back

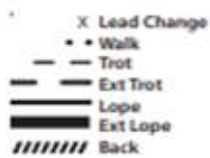
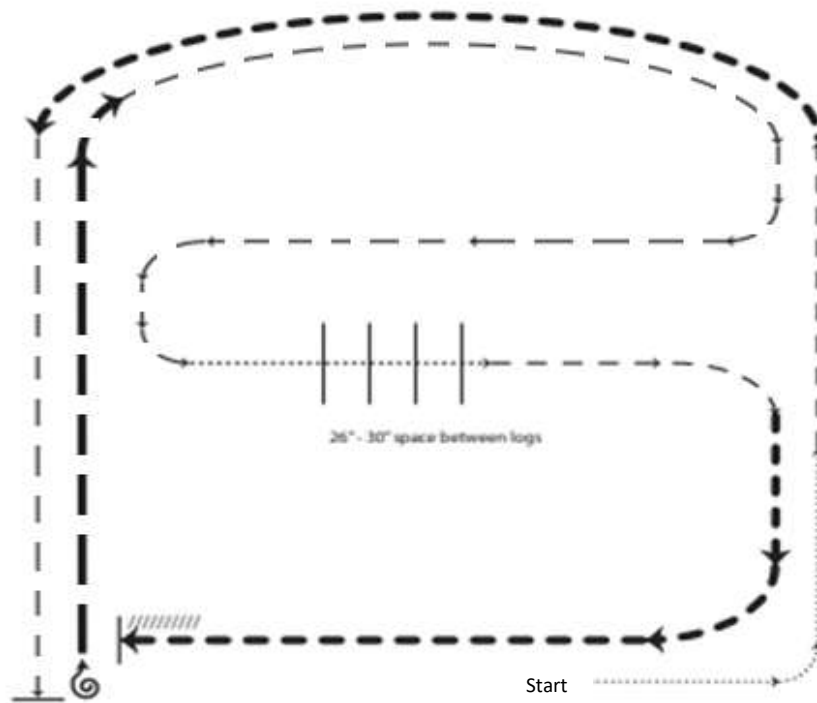

1. Walk
2. Trot
3. Extended trot
4. Trot
5. Stop, 1 1/2 turn right
6. Extended trot
7. Collect to working trot
8. Walk
9. Walk over logs
10. Trot
11. Extended trot
12. Stop and back

RANCH RIDING - PATTERN 3

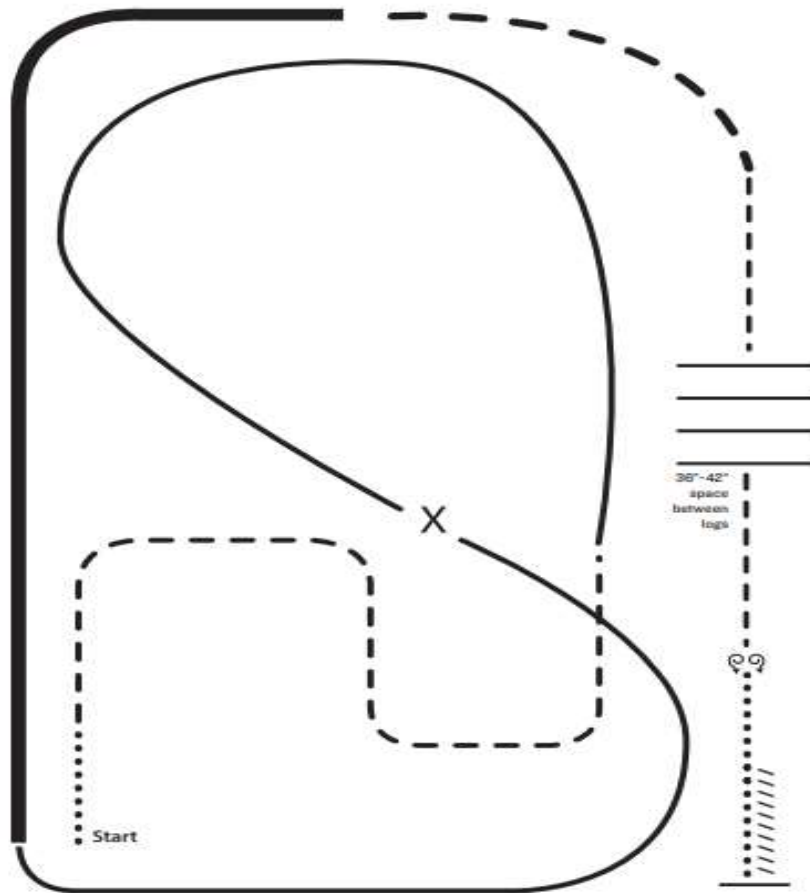

- X Lead Change
- Walk
- - - Trot
- - - - Ext trot
- Lope
- Ext Lope
- //// Back

Note: The drawn description of this pattern is only intended for the general depiction of the pattern. Exhibitors should utilize the arena space to best exhibit their horses.

1. Walk
2. Trot serpentine
3. Lope left lead around the end of the arena and then diagonally across the arena
4. Change leads (simple or flying) and
5. Lope on the right lead around end of the arena
6. Extend lope on the straight away and around corner to the center of the arena
7. Extend trot around corner of the arena
8. Collect to a trot
9. Trot over logs
10. Stop, do 360 degree turn each direction (either direction 1st) (L-R or R-L)
11. Walk, stop and back

RANCH RIDING - PATTERN 3

WALK TROT

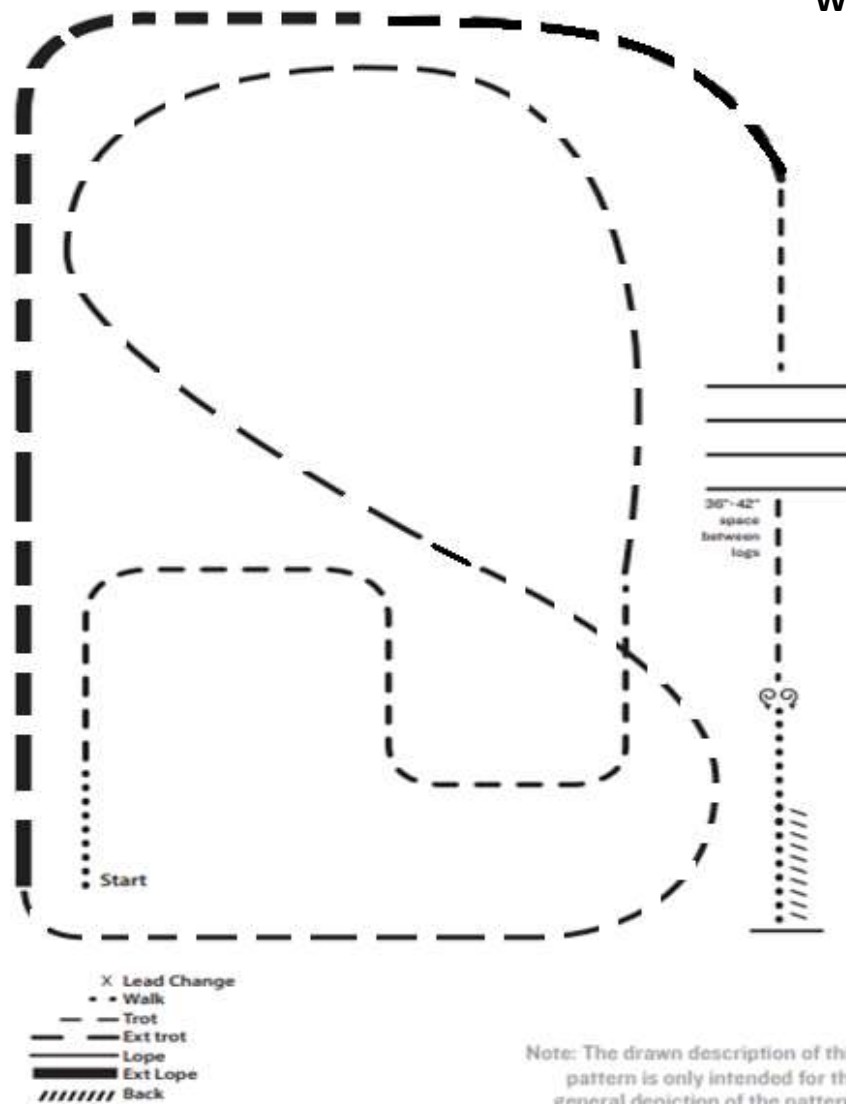

1. Walk
2. Trot serpentine
3. Trot around the end of the arena and then diagonally across the arena
5. Trot around end of the arena
6. Extend trot on the straight away and around corner to the center of the arena
7. Extend trot around corner of the arena
8. Collect to a trot
9. Trot over logs
10. Stop, do 360 degree turn each direction (either direction 1st) (L-R or R-L)
11. Walk, stop and back

RANCH RIDING - PATTERN 4

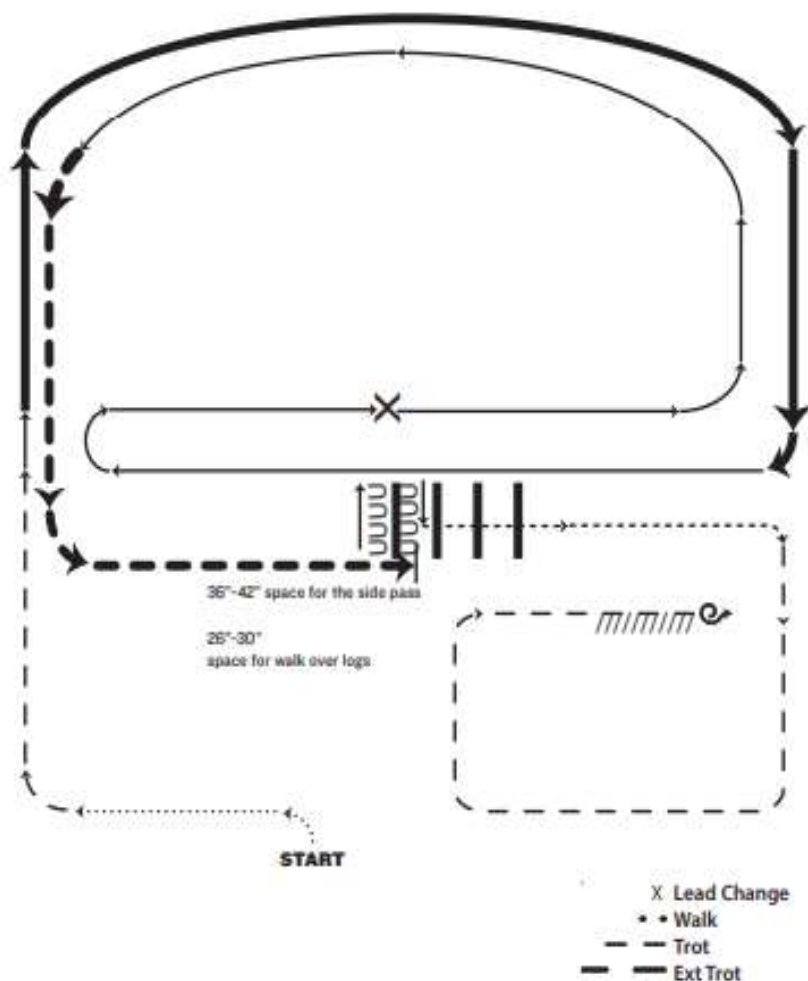

1. Walk
2. Trot
3. Extended lope right lead
4. Lope right lead
5. Change leads (simple or flying)
6. Lope left lead
7. Extended trot
8. Stop, side pass left, side pass right, 1/2 way
9. Walk over logs
10. Walk
11. Trot square
12. Stop, 360° turn left, back

RANCH RIDING - PATTERN 4

WALK TROT

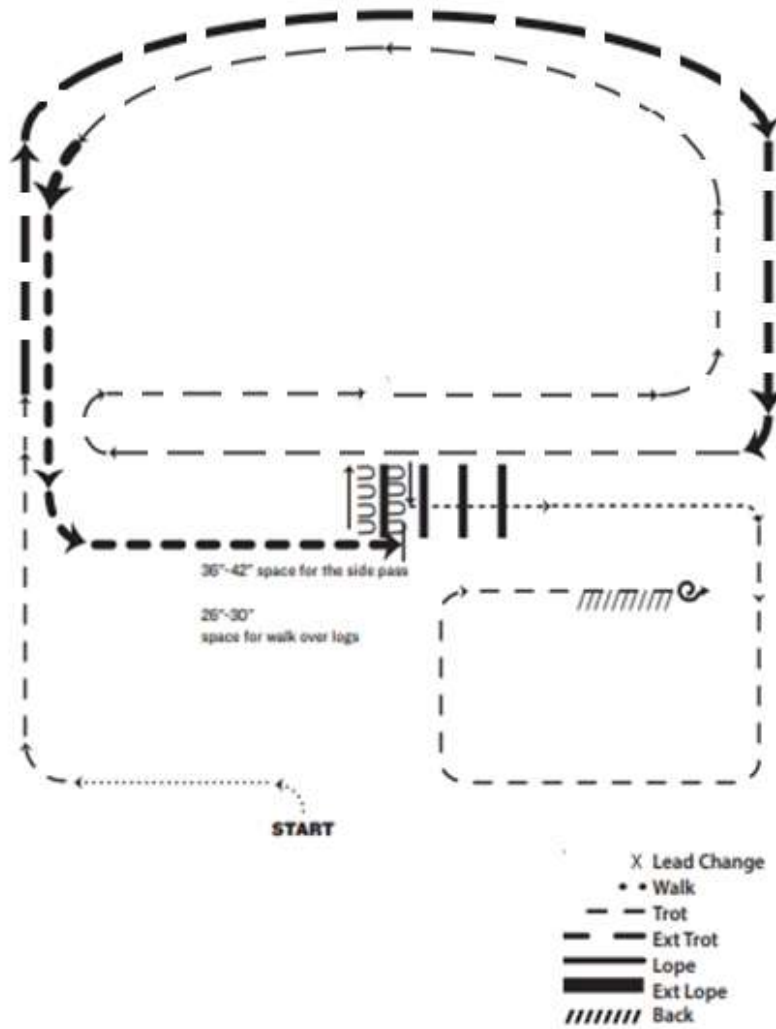

1. Walk
2. Trot
3. Extended Trot
4. Trot
5. Extended trot
6. Stop, side pass left, side pass right, 1/2 way
7. Walk over logs
8. Walk
9. Trot square
10. Stop, 360° turn left, back

RANCH RIDING - PATTERN 5

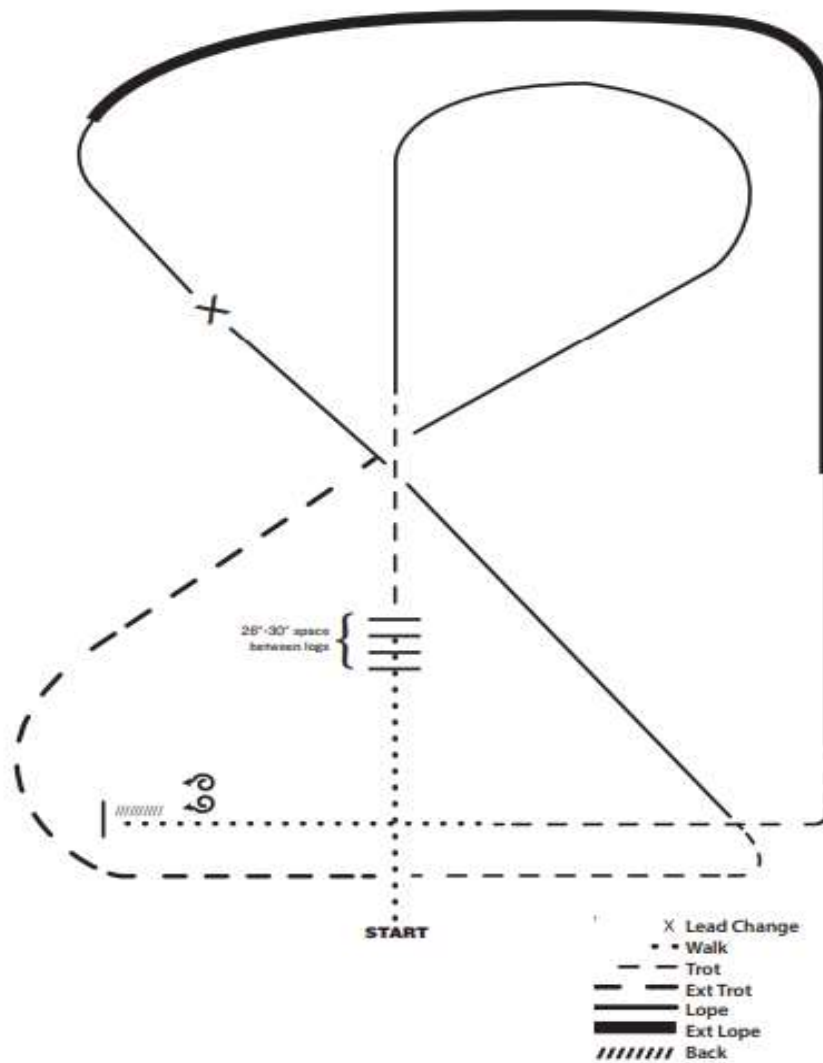

1. Walk
2. Walk over logs
3. Trot
4. Lope right lead
5. Extended trot
6. Trot
7. Lope left lead
8. Change leads (simple or flying)
9. Right lead, extended lope
10. Collect Lope
11. Trot
12. Walk
13. Stop and back
14. 360 degree turn each direction (either direction 1st) (L-R or R-L)

RANCH RIDING - PATTERN 5

WALK TROT

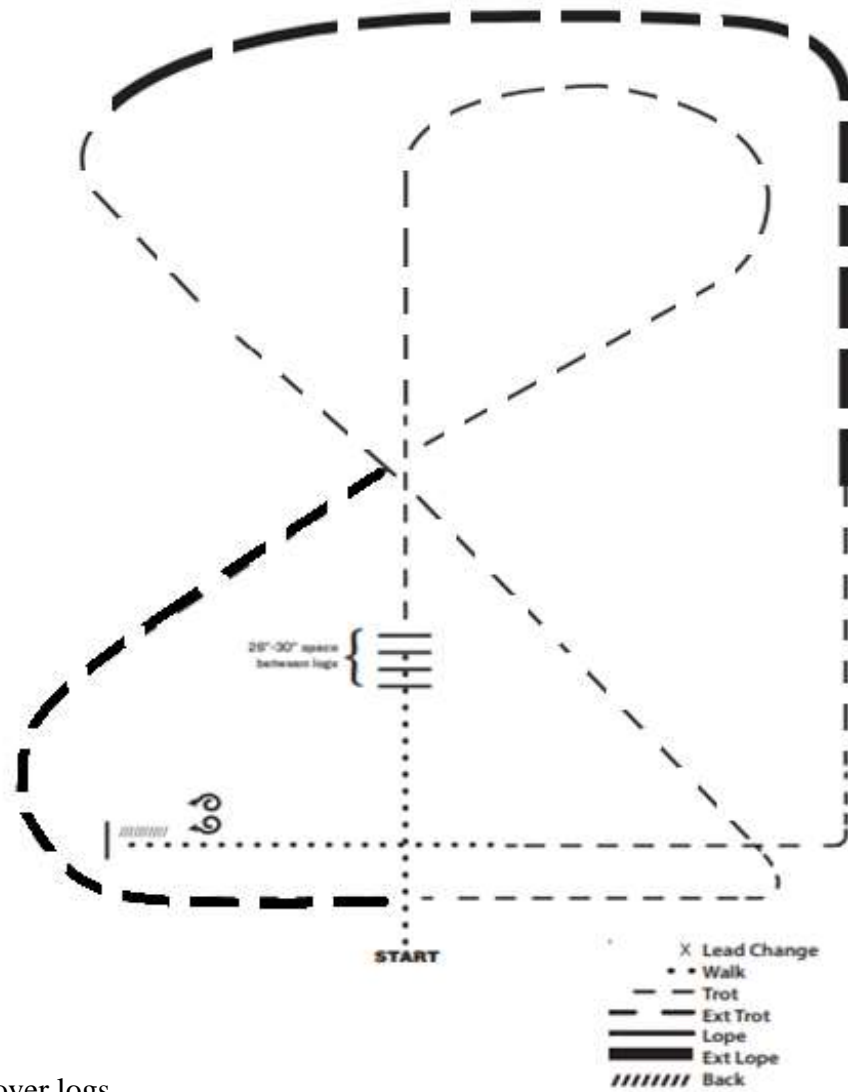

1. Walk
2. Walk over logs
3. Trot
4. Extended trot
5. Trot
6. Extended trot
7. Trot
8. Walk
9. Stop and back
10. 360 degree turn each direction (either direction 1st) (L-R or R-L)

RANCH RIDING - PATTERN 6

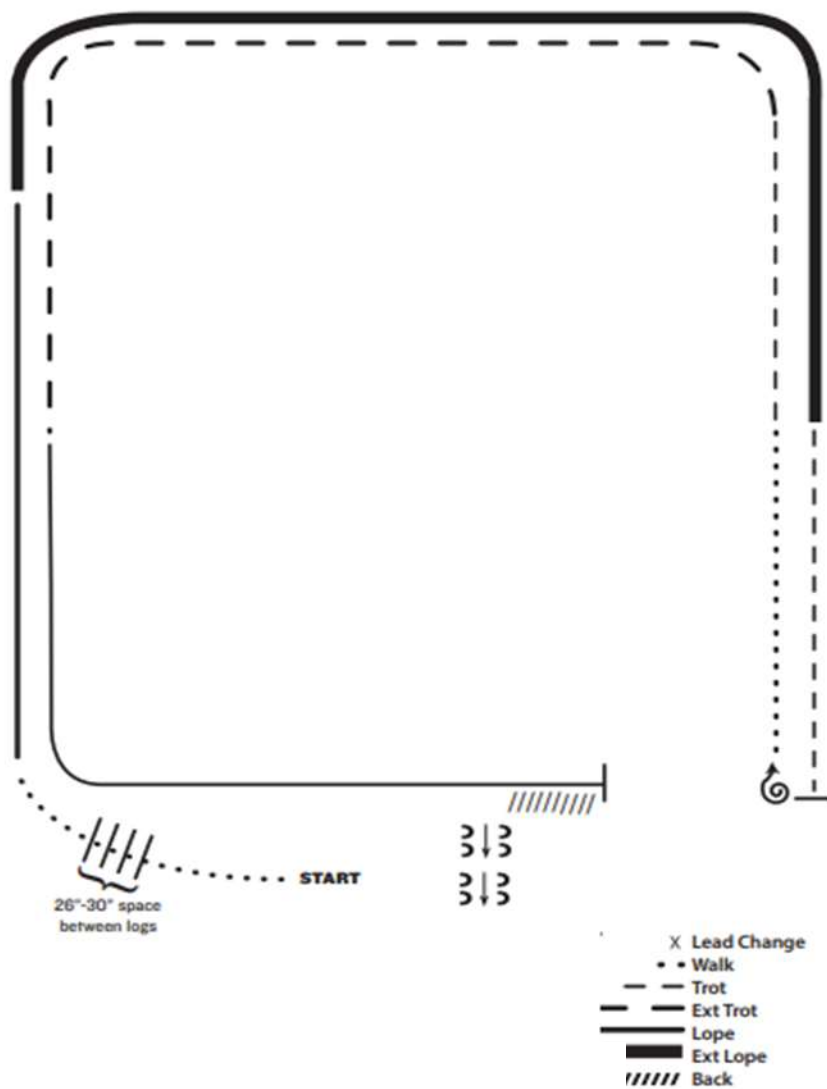

1. Walk
2. Walk over logs
3. Lope right lead
4. Extended lope (right lead)
5. Trot
6. Stop, 1 1/2 turns right
7. Walk
8. Trot
9. Extended trot
10. Lope left lead
11. Stop and Back
12. Side pass right

RANCH RIDING - PATTERN 6

WALK TROT

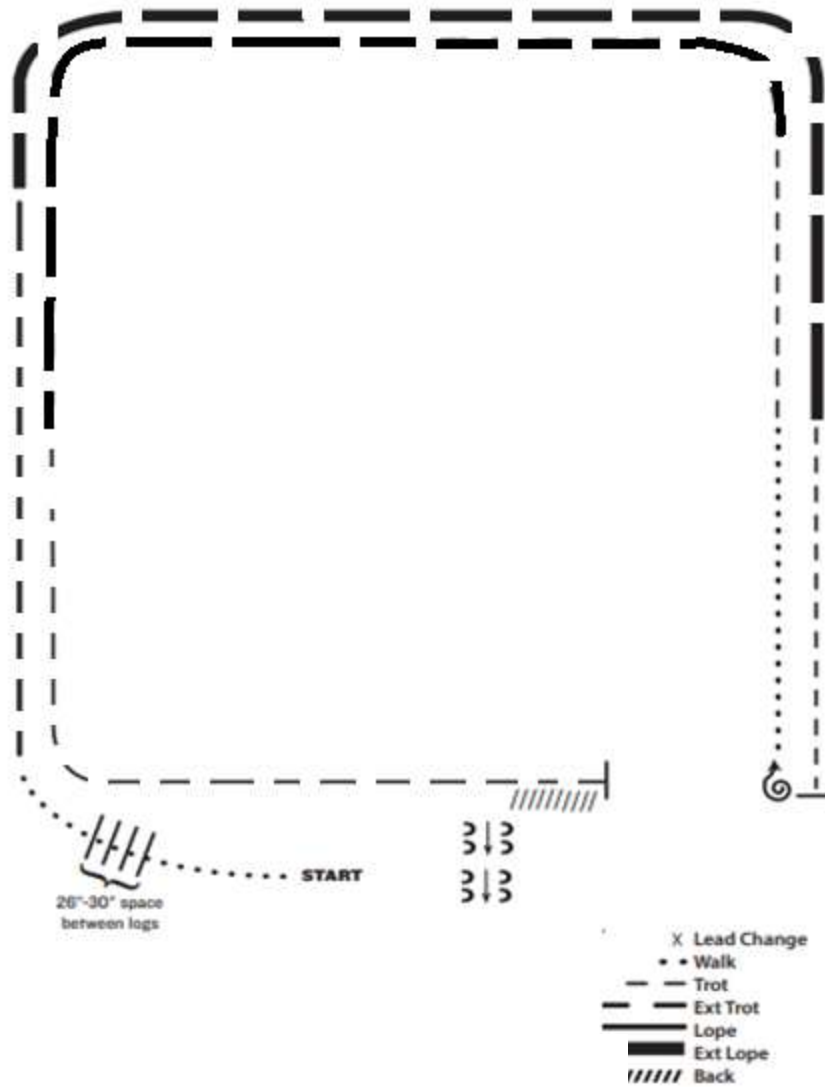

1. Walk
2. Walk over logs
3. Trot
4. Extended Trot
5. Trot
6. Stop, 1 1/2 turns right
7. Walk
8. Trot
9. Extended trot
10. Trot
11. Stop and Back
12. Side pass right

RANCH RIDING – PATTERN 7

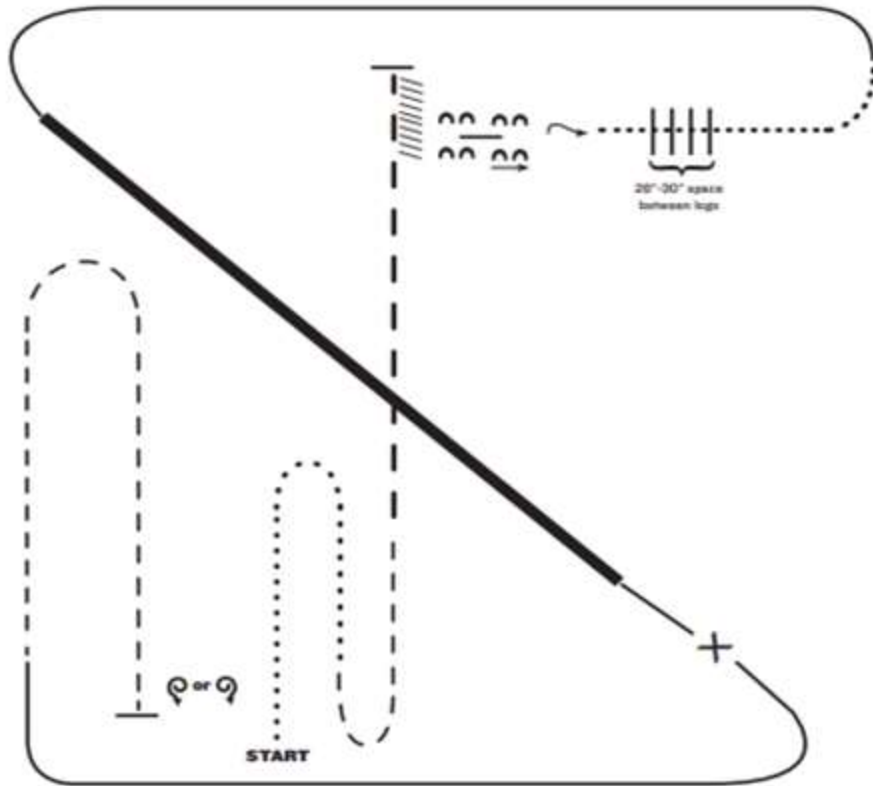

- X Lead Change
- Walk
- - Trot
- Ext Trot
- Lope
- Ext Lope
- //// Back

1. Walk
2. Trot
3. Extended trot
4. Stop and back
5. Side pass over log right
6. 1/4 turn right, walk over logs
7. Walk
8. Lope left lead
9. Extended lope (left lead)
10. Collect lope, change leads (simple or flying)
11. Lope right lead
12. Trot
13. Stop, one 360 degree turn either direction

RANCH RIDING - PATTERN 7

WALK TROT

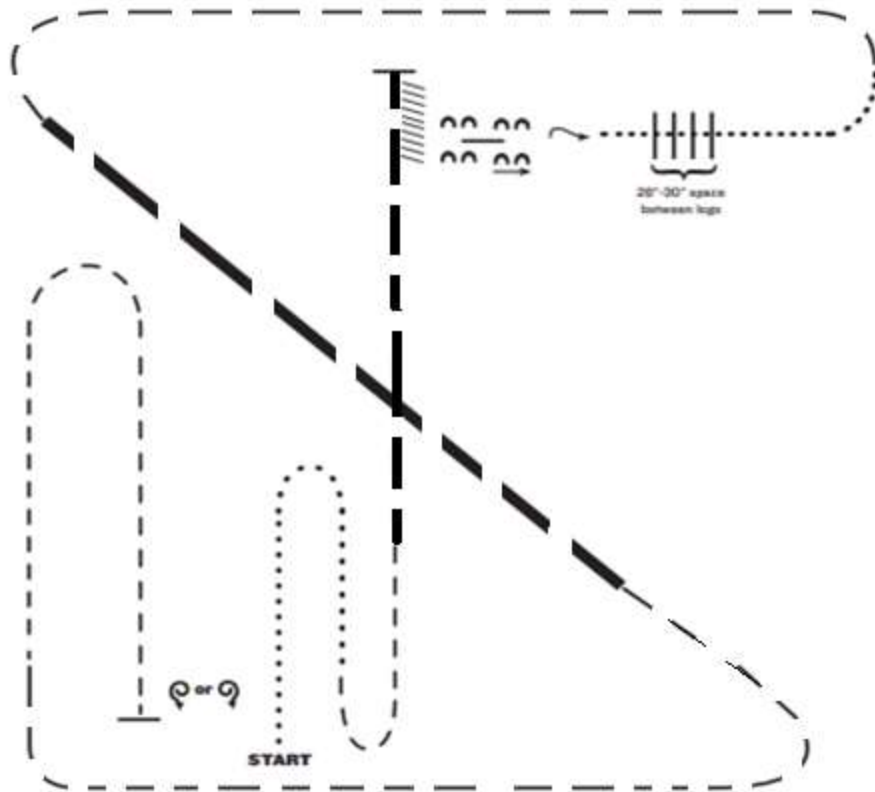

1. Walk
2. Trot
3. Extended trot
4. Stop and back
5. Side pass over log right
6. 1/4 turn right, walk over logs
7. Walk
8. Trot
9. Extended Trot
10. Trot
11. Stop, one 360 degree turn either direction

RANCH RIDING - PATTERN 8

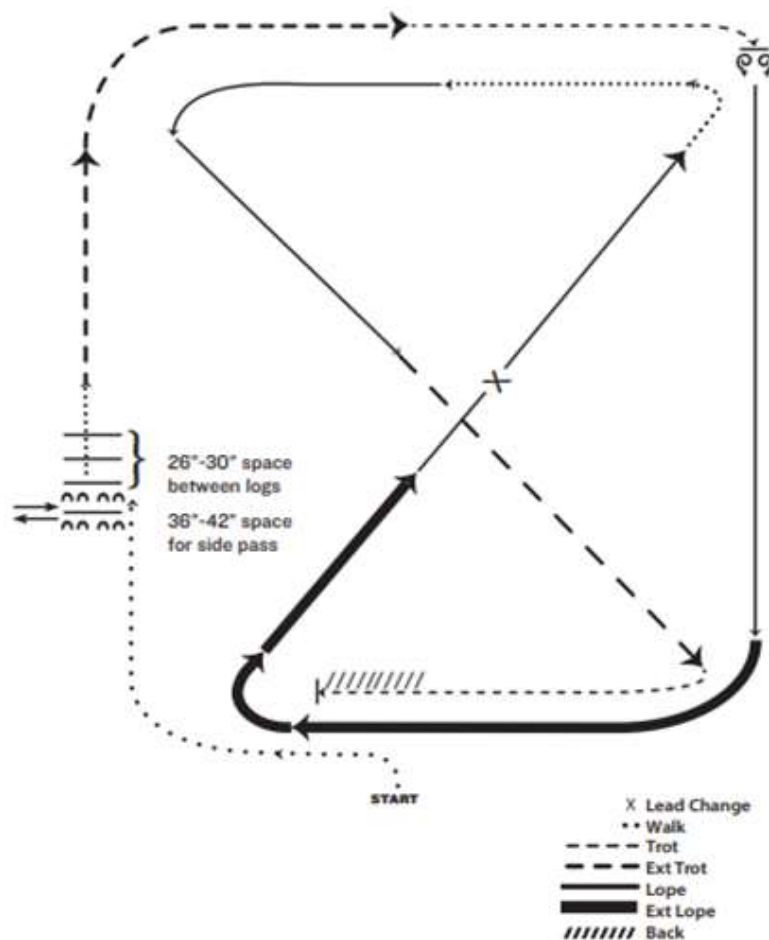

1. Walk
2. Side pass left across first log, side pass 1/2 way to right
3. Walk across logs
4. Extended trot
5. Trot
6. Stop, 360 degree turn each direction (either direction 1st) (L-R or R-L)
7. Lope right lead
8. Extended lope (right lead)
9. Collect lope, change leads (simple or flying)
10. Walk
11. Lope left lead
12. Extended trot
13. Trot
14. Stop and back

RANCH RIDING - PATTERN 9

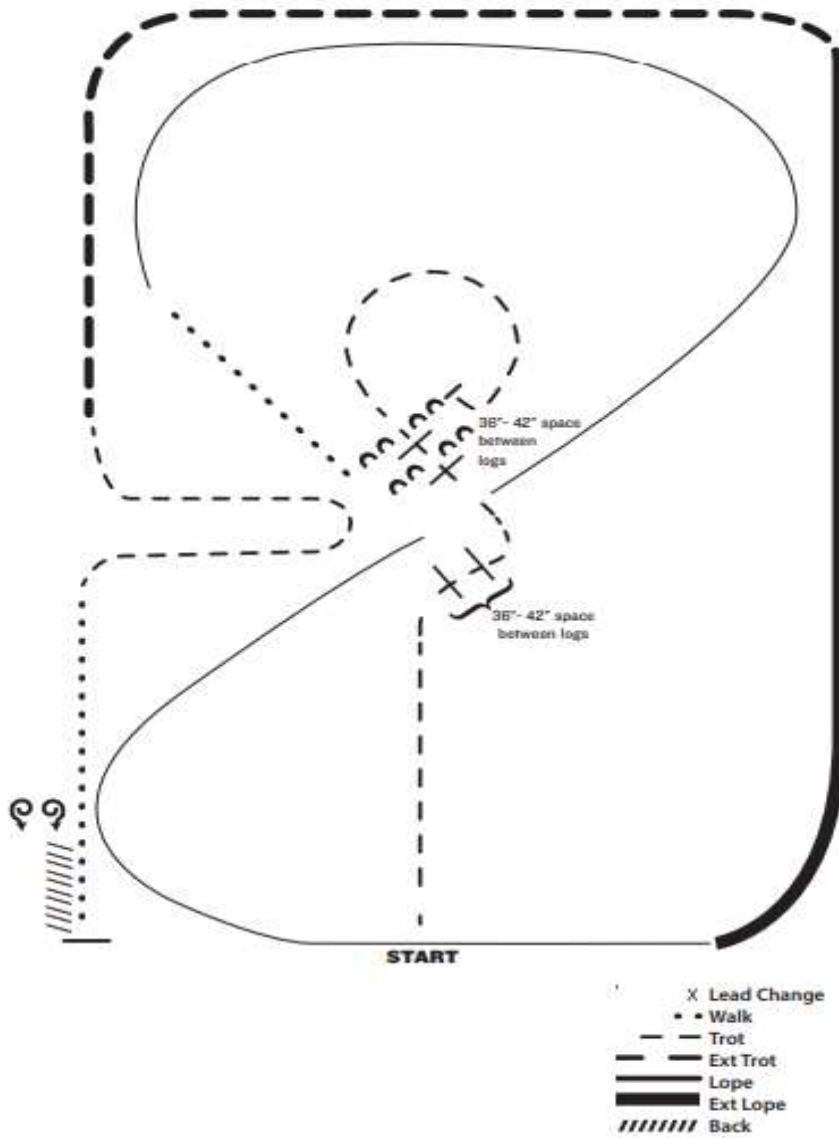

1. Trot
2. Trot two sets of logs
3. Trot circle, stop and side pass log left
4. Walk
5. Lope right lead
6. Change leads (simple or flying)
7. Lope left lead
8. Extended lope (left lead)
9. Extended trot
10. Trot
11. Walk
12. Stop and back
13. 360 degree turn each direction (either direction 1st) (L-R or R-L)

RANCH RIDING - PATTERN 9

WALK TROT

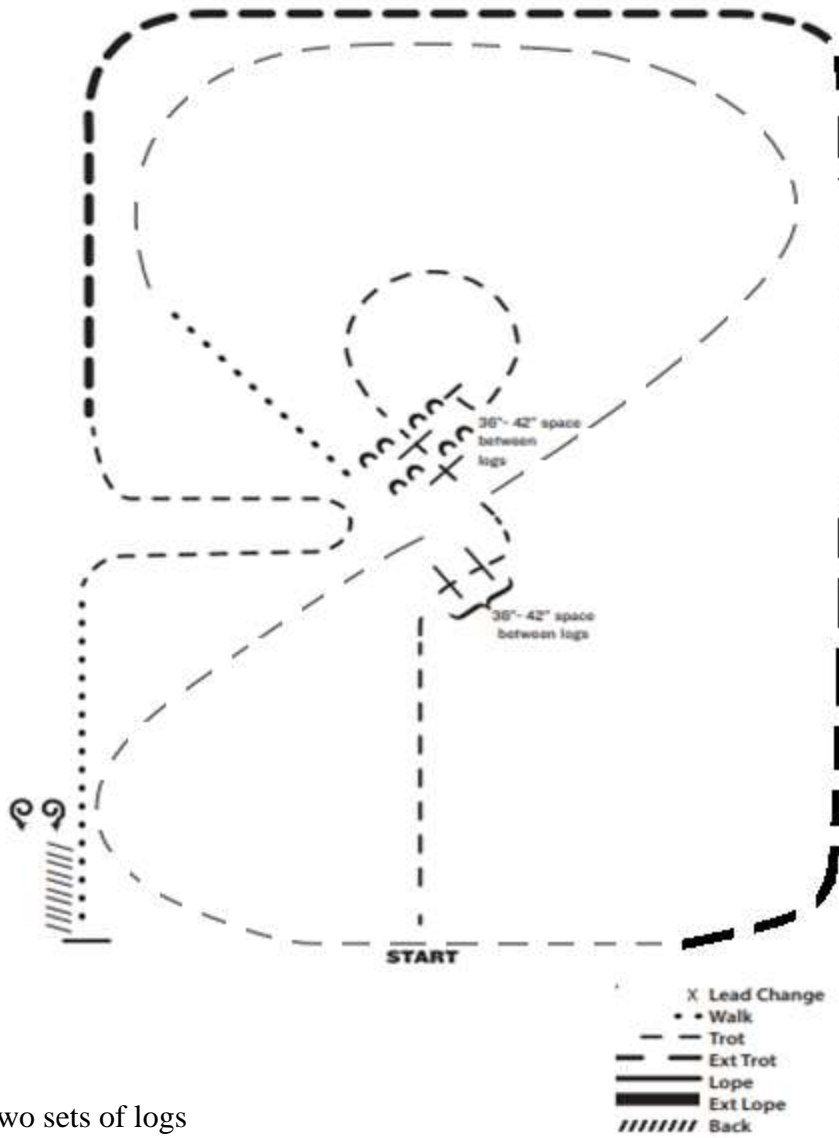

1. Trot
2. Trot two sets of logs
3. Trot circle, stop and side pass log left
4. Walk
5. Trot
6. Extended trot
7. Trot
8. Walk
9. Stop and back
10. 360 degree turn each direction (either direction 1st) (L-R or R-L)

RANCH RIDING - PATTERN 10

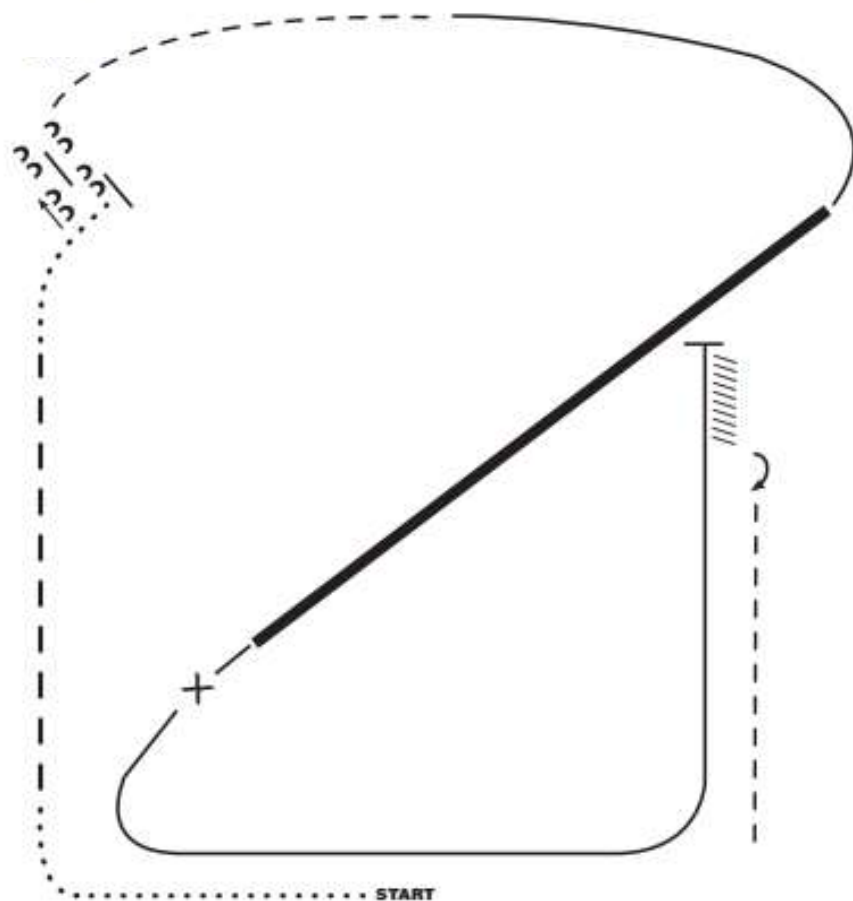

1. Walk
2. Extended trot
3. Walk
4. Stop, side pass log left
5. Trot
6. Lope right lead
7. Extended Lope (right lead)
8. Collect lope and change leads (simple or flying)
9. Lope left lead
10. Stop and back
11. 180 turn to right
12. Trot

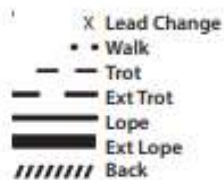

RANCH RIDING - PATTERN 10

WALK TROT

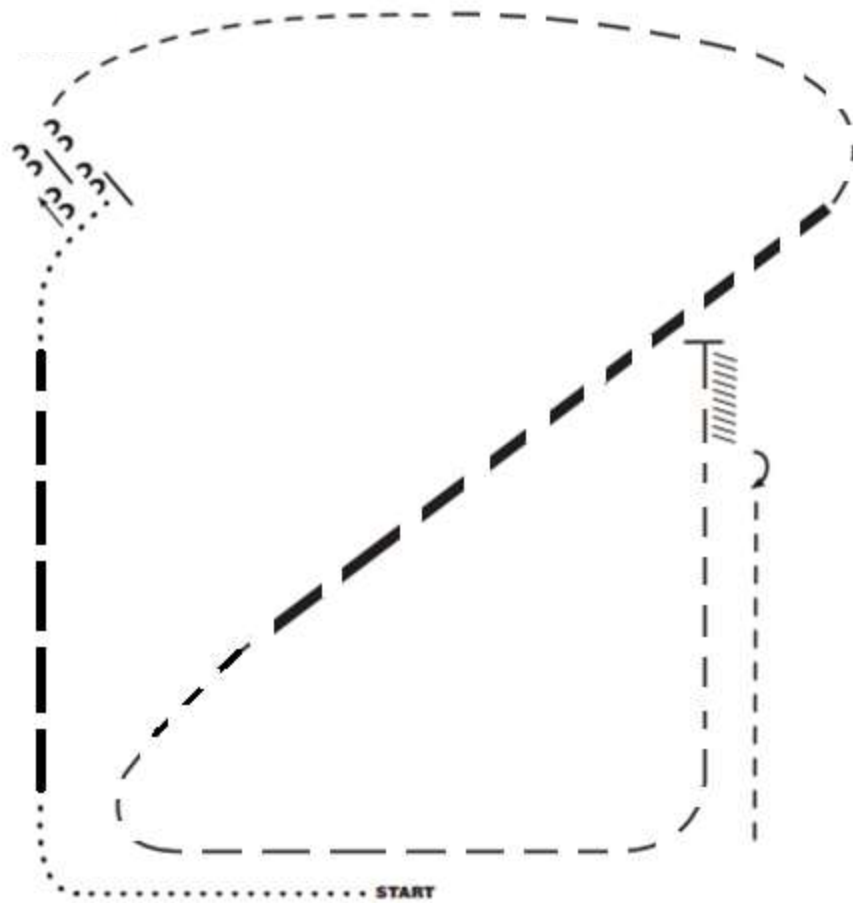

1. Walk
2. Extended trot
3. Walk
4. Stop, side pass log left
5. Trot
7. Extended Trot
8. Trot
9. Stop and back
10. 180 turn to right
11. Trot

X Lead Change
••• Walk
- - - Trot
- - - Ext Trot
- - - Lope
- - - Ext Lope
////// Back

RANCH RIDING - PATTERN 11

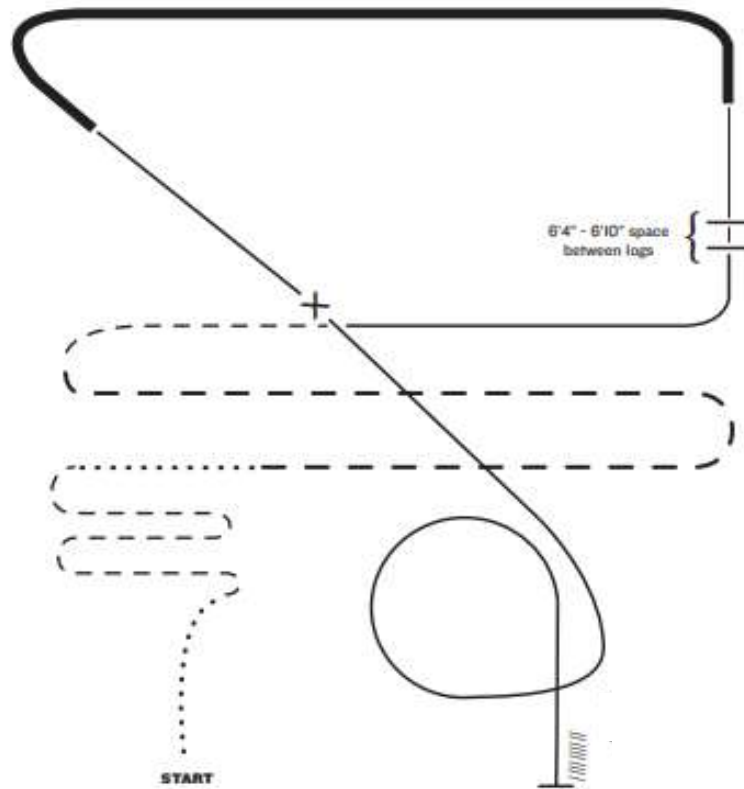

1. Walk
2. Trot serpentine
3. Walk
4. Extended trot
5. Trot
6. Lope left lead
7. Lope over logs
8. Extended lope (left lead)
9. Collect lope, change leads (simple or flying)
10. Lope right lead
11. Lope circle
12. Stop and back

X Lead Change

- • Walk
- - Trot
- - Ext Trot
- — Lope
- — Ext Lope
- //// Back

RANCH RIDING - PATTERN 11

WALK TROT

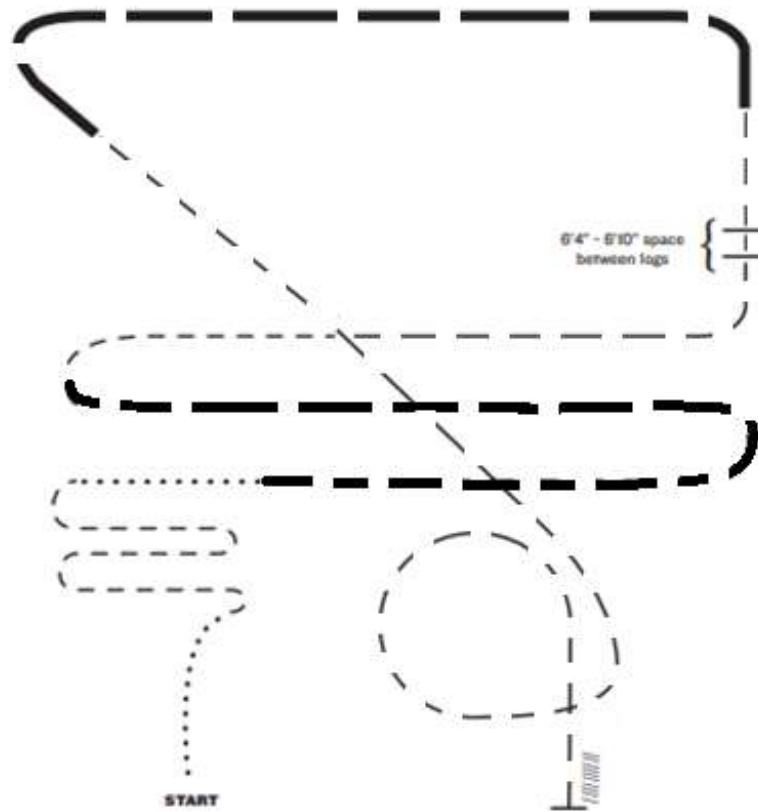

1. Walk
2. Trot serpentine
3. Walk
4. Extended trot
5. Trot
6. Trot over logs
7. Extended Trot
8. Collect Trot
9. Trot circle
10. Stop and back

X Lead Change

- • Walk
- - Trot
- - Ext Trot
- ==== Lope
- ==== Ext Lope
- //// Back

RANCH RIDING - PATTERN 12

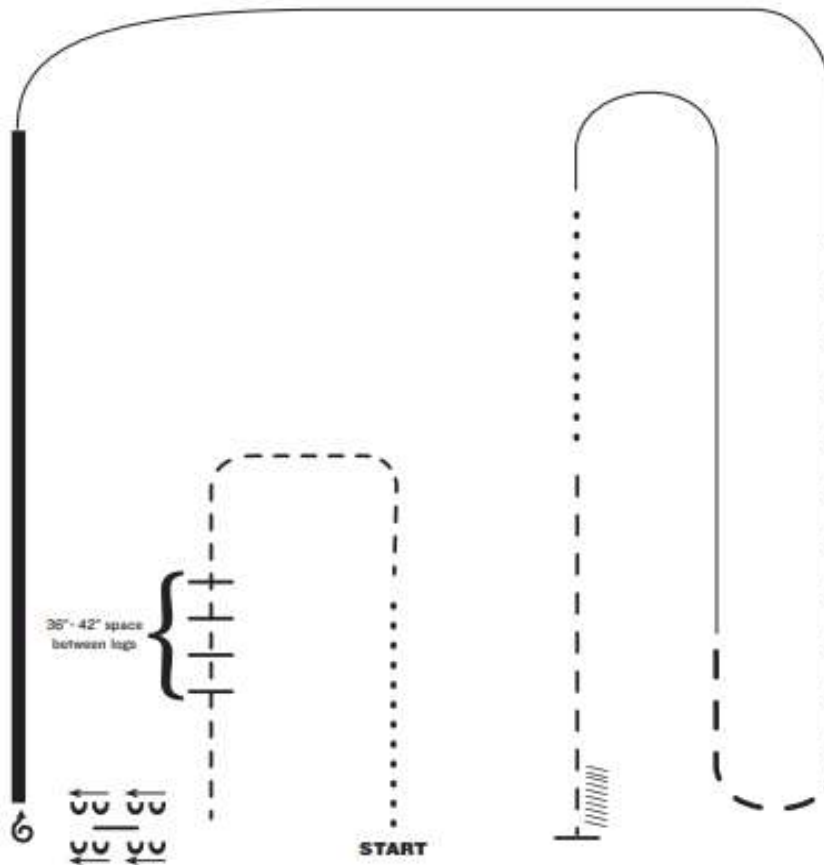

1. Walk
2. Trot
3. Trot logs
4. Side pass right over log
5. 1 1/2 turns right
6. Extended lope (right lead)
7. Lope right lead
8. Extended trot
9. Lope left lead
10. Walk
11. Trot
12. Stop and back



RANCH RIDING - PATTERN 12

WALK TROT

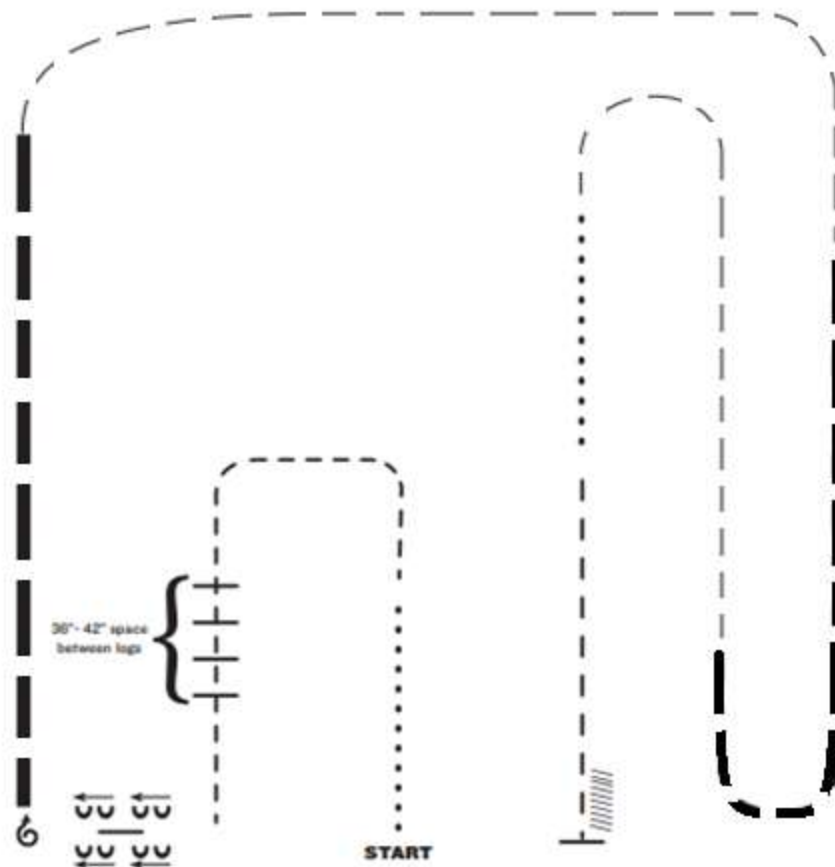

1. Walk
2. Trot
3. Trot logs
4. Side pass right over log
5. 1 1/2 turns right
6. Extended Trot
7. Trot
8. Extended trot
9. Trot
10. Walk
11. Trot
12. Stop and back

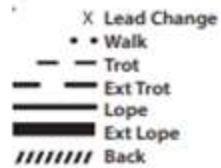

RANCH RIDING - PATTERN 13

WALK TROT

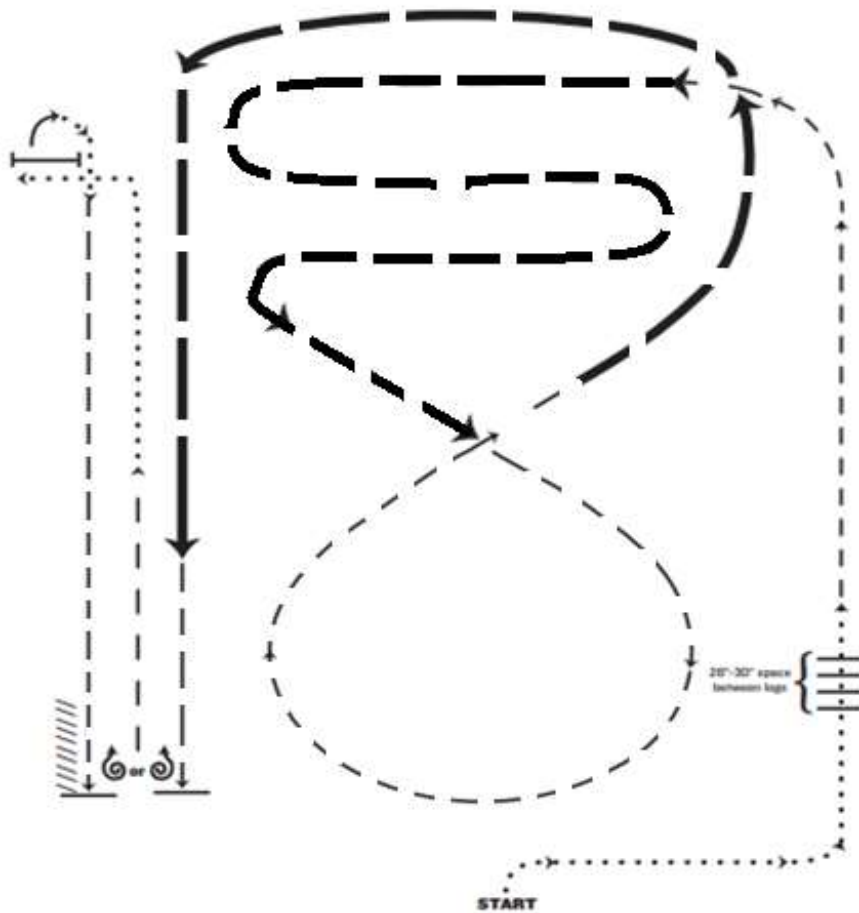

1. Walk
2. Walk over logs
3. Trot
4. Extended trot serpentine
5. Trot
7. Extended Trot, collect Trot
8. Stop, 1 1/2 turn, either direction
9. Trot
10. Walk to gate
11. Right hand push gate
12. Walk, Trot
13. Stop and back

X Lead Change
 — Walk
 - - - Trot
 - - - Ext Trot
 — Lope
 - - - Ext Lope
 // // // // Back

RANCH RIDING - PATTERN I4

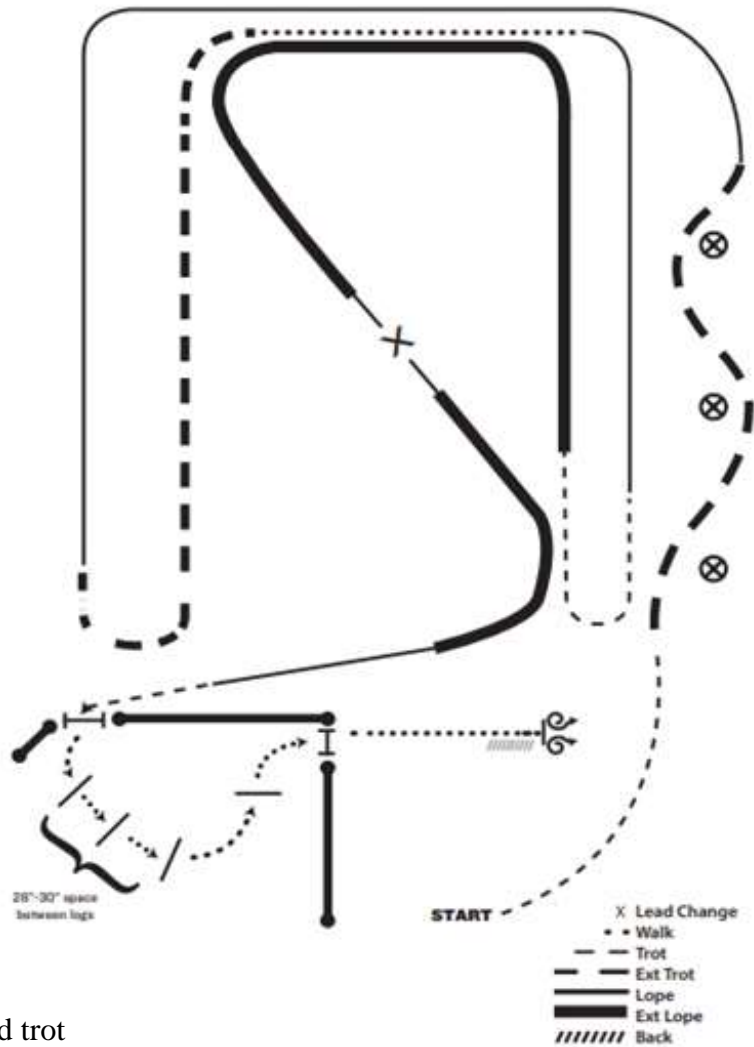

1. Trot
2. Extended trot
3. Lope left lead
4. Extended trot
5. Walk
6. Lope right lead
7. Trot
8. Extended lope (left lead)
9. Collect lope, change leads (simple or flying), extended lope (right lead), collect lope
10. Trot
11. Left hand push gate into pen
12. Walk over logs
13. Right hand push gate out of pen
14. Walk
15. Stop, 360 degree turn each direction (either direction 1st) (L-R or R-L)
16. Back

RANCH RIDING - PATTERN 14

WALK TROT

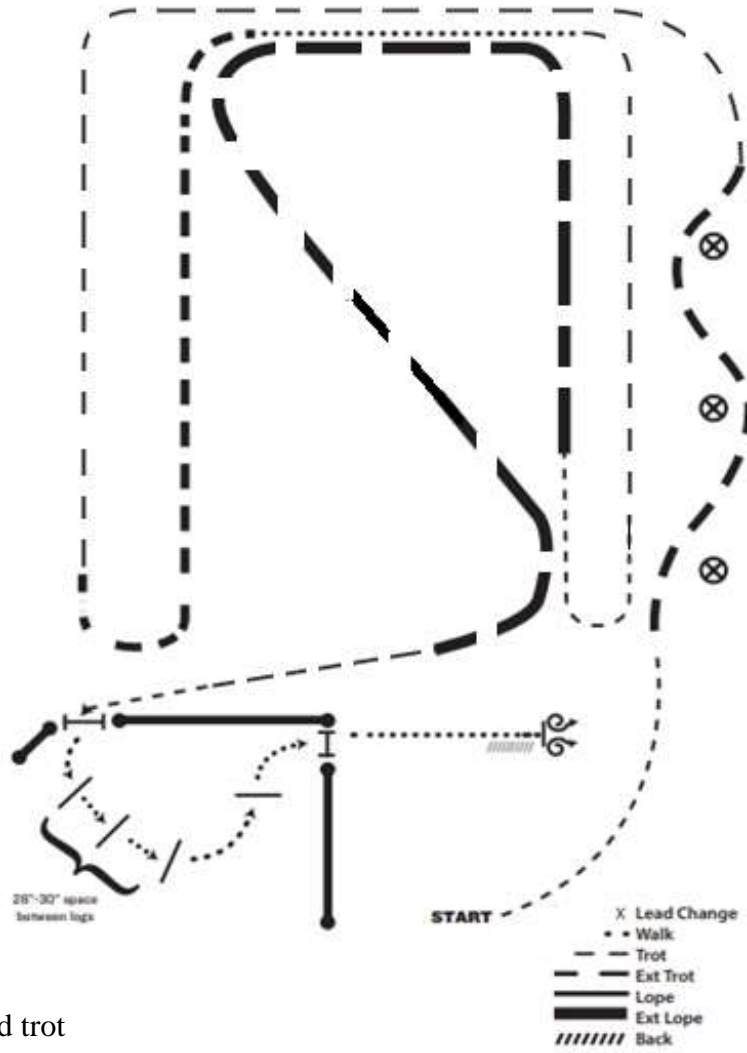

1. Trot
2. Extended trot
3. Trot
4. Extended trot
5. Walk
6. Trot
7. Extended Trot
8. Trot
9. Left hand push gate into pen
10. Walk over logs
11. Right hand push gate out of pen
12. Walk
13. Stop, 360 degree turn each direction (either direction 1st) (L-R or R-L)
14. Back

RANCH RIDING - PATTERN 15

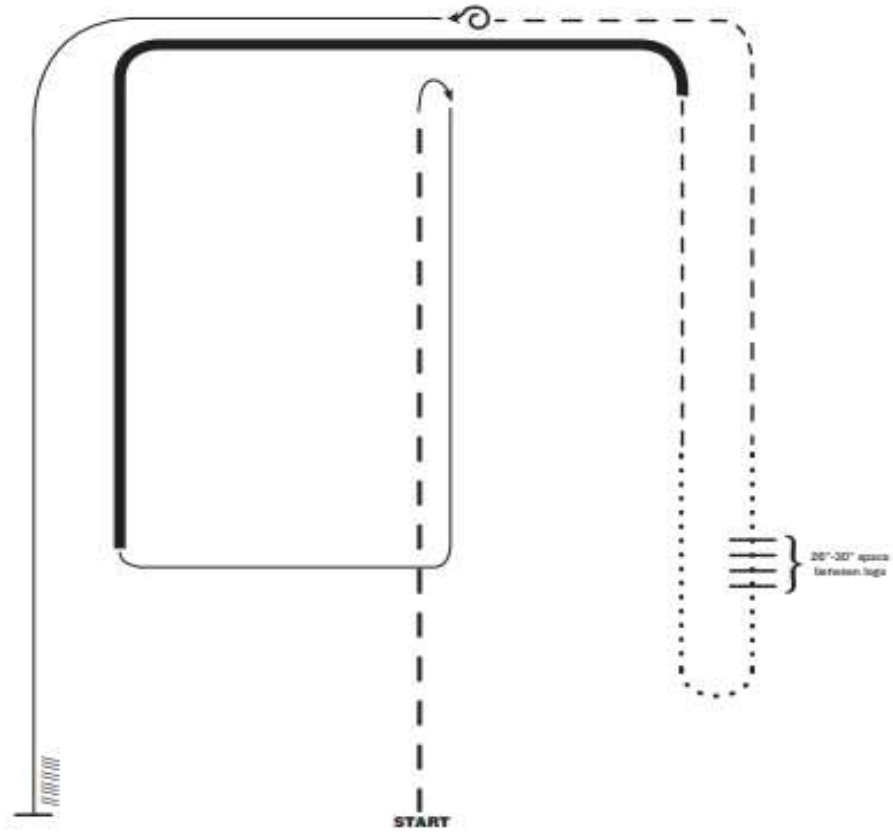

1. Extended trot
2. Stop, rollback right
3. Lope right lead
4. Extended lope (right lead)
5. Trot
6. Walk
7. Walk over logs
8. Walk
9. Trot
10. Stop, 360 left
11. Lope left lead
12. Stop and back



RANCH REINING

1. The ranch horse reining class measures the ability of the ranch horse to perform basic handling maneuvers with a natural head carriage in a forward-looking manner. The ideal ranch reining horse should have a natural ranch horse appearance from head to tail in each maneuver.
2. To rein a horse is not only to guide him but also to control his every movement. The best reined horse should be willingly guided or controlled with little or no apparent resistance and dictated to completely. Any movement on his own must be considered a lack of control. All deviations from the exact written pattern must be considered a lack of or temporary loss of control and therefore a fault that must be marked down according to severity of deviation.
3. All runs begin upon entering the pen and any infractions are subject to penalty at that time such as two hands on the reins except with a snaffle bit or bosal, using either hand to instill fear or praise, etc.
4. Excess rein may be straightened anytime during the pattern, provided the rider's free hand remains behind the rein hand.
5. Holding the saddle horn with either hand will not be penalized in any class.

RANCH REINING SCORING RUBRIC:

The scoring system is designed to give credit for the work done. Each horse/rider team is scored between 0-100 points and automatically begins the run with a score of 70 points. The horse/rider team is scored on the quality of each maneuver (e.g., -1 1/2 extremely poor, -1 very poor, -1/2 poor, 0 correct, +1/2 Good, +1 very good, +1 1/2 excellent). Pluses and minuses are a reflection of the horse/rider team's overall performance should be credited for smoothness, finesse, attitude, quickness, and authority of performing various maneuvers while using controlled speed which raises the degree of difficulty and makes the horse/rider team more exciting and pleasing to watch.

PENALTIES:

½ Point Penalties:

- starting a circle or exiting a rollback at a trot for up to two (2) strides;
- delayed change of lead by one stride where the lead change is required by the pattern description;
- failure to remain a minimum of twenty feet from the wall or fence when approaching a stop and/or roll-back;
- over-spin or under-spin up to 1/8 turn.

1 Point Penalties:

- over-bridled (per maneuver);
- out of lead in the circles;
- figure eights or around the end of the arena (this penalty is cumulative and will be deducted for each quarter of a circle the horse is out of lead);
- over or under spinning 1/8 to 1/4 turn;
- slipping rein.

2 Point Penalties:

- Break of gait;
- freeze up in spins or rollbacks;
- failure to stop or walk before executing a lope departure on trot-in patterns;
- failure to be in a lope prior to the first marker on run-in patterns;
- failure to completely pass the specified marker before initiating a stop position, when starting a circle, run-down or exiting a rollback;
- trotting beyond two strides but less than 1/2 circle or 1/2 length of the arena.

5 Point Penalties:

- spurring in front of cinch;
- blatant disobedience;
- use of either hand to instill fear/praise.

Off-Pattern (OP):

Exhibitors cannot place above others who complete the pattern correctly.

- breaking pattern;
- inclusion of maneuver (e.g. over or under-spinning, backing more than two (2) strides, etc.);
- trotting in excess of 1/2 circle or 1/2 length of the arena;
- more than one finger between split reins or any fingers between romal reins (except two rein);
- use of two hands (except in snaffle bit or hackamore);
- any attempt to alter tension or length of the reins from the bridle to the rein hand is considered use of two hands and an OP will be applied.
- repeated blatant disobedience.

Disqualification (DQ):

Disqualified entries are counted as an entry in the class but cannot receive points or credits for that class.

- lameness;
- abuse;
- illegal equipment;
- disrespect or misconduct;
- improper western attire;
- leaving the working area before pattern is complete;
- fall of horse/ rider (run ends; scores will be given for work done but the horse/rider team will be disqualified and will not be placed).

VRH AND RHC RANCH REINING PATTERN I

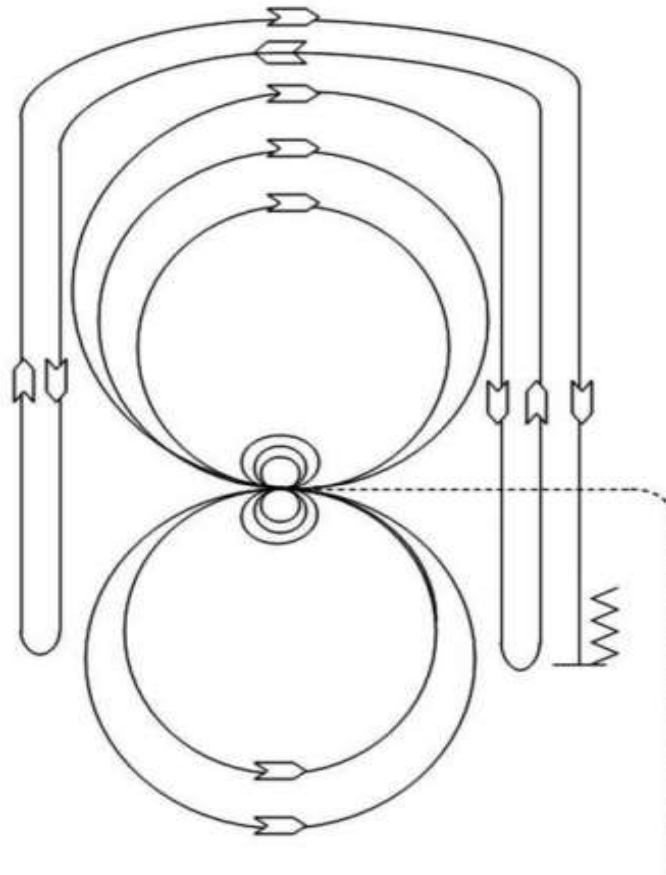

Mandatory Markers along Fence or Wall The judge shall indicate with markers on arena fence or wall the center of the pattern.

Ride pattern as follows: Trot to center of arena and stop.

1. Complete 3 spins in one direction. Hesitate.
2. Complete 3 spins in the opposite direction. Hesitate.
3. Beginning on right lead, complete two large fast circles to the right. Change leads at center of arena.
4. Complete two large fast circles to the left. Change leads at center of arena.
5. Begin a large circle to the right but do not close this circle. Run down the right side of the arena past the center marker and do a left roll back at least 20 feet from the wall or fence, no hesitation.
6. Continue back around the previous circle but do not close this circle. Run down the left side of the arena past the center marker and do a right roll back at least 20 feet from the wall or fence, no hesitation.
7. Continue back around previous circle, but do not close this circle. Run down the right side of the arena past the center marker and do a sliding stop at least 20 feet from the wall or fence. Back up at least 10 feet. Hesitate to show completion of pattern.

VRH AND RHC RANCH REINING PATTERN 2

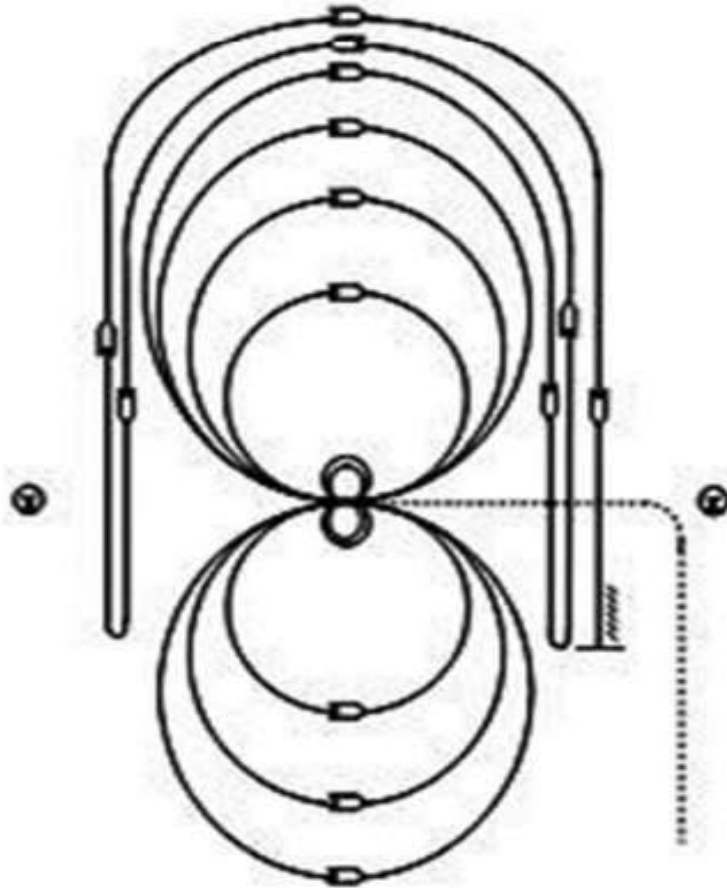

Mandatory Markers along Fence or Wall The judge shall indicate with markers on arena fence or wall the center of pattern.

- Ride pattern as follows: Trot to center of arena and stop or walk before departure.
1. Beginning on right lead, complete two circles to the right - the first one large and fast; the second one small and slow. Stop at center.
 2. Complete 4 spins to the right. Hesitate.
 3. Beginning on left lead, complete two circles to the left - the first one large and fast; the second one small and slow. Stop at center.
 4. Complete 4 spins to the left. Hesitate.
 5. Beginning on the right lead, complete a large fast circle to the right and change leads at center of arena. Complete a large fast circle to the left and change leads at center of arena.
 6. Begin a large fast circle to the right, but do not close this circle. Run down the right side of the arena, past the center marker, and do a left roll back at least 20 feet from the wall or fence.
 7. Continue back around the previous circle, but do not close this circle. Run down the left side of the arena, past the center marker, and do a right roll back at least 20 feet from the wall or fence.
 8. Continue back around previous circle, but do not close this circle. Run down right side of the arena, past the center marker, and do a sliding stop at least 20 feet from the wall or fence. Back up at least 10 feet. Hesitate to show completion of pattern.

VRH AND RHC RANCH REINING PATTERN 3

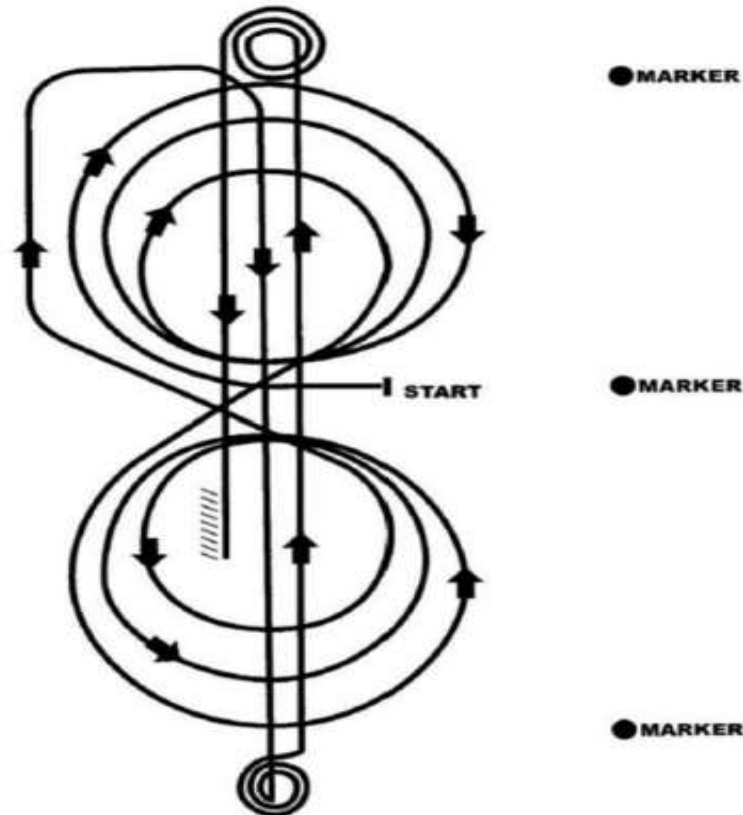

Mandatory Marker along Fence or Wall: The judge shall indicate with markers on arena fence or wall the center of pattern. Judge shall also place markers on fence or wall at least 50' from each end of the arena.

Ride pattern as follows: Trot to center of arena and stop or walk before departure. Start pattern facing toward judge.

1. Beginning on right lead, complete three circles to the right - the first two large and fast; the third one small and slow. Change leads at center of arena.
2. Complete three circles to the left - the first two large and fast; the third one small and slow. Change leads at center of arena.
3. Begin a large circle to the right, but do not close this circle. Run down center of arena, past the end marker, and do a sliding stop.
4. Complete 3 1/2 spins to the right.
5. Run up center of arena to the opposite end, past the end marker, do a sliding stop.
6. Complete 3 1/2 spins to the left.
7. Run back to the middle of the arena, past the center marker, and do a sliding stop. Back up at least 10 feet. Hesitate to show completion of pattern

VRH AND RHC RANCH REINING PATTERN 4

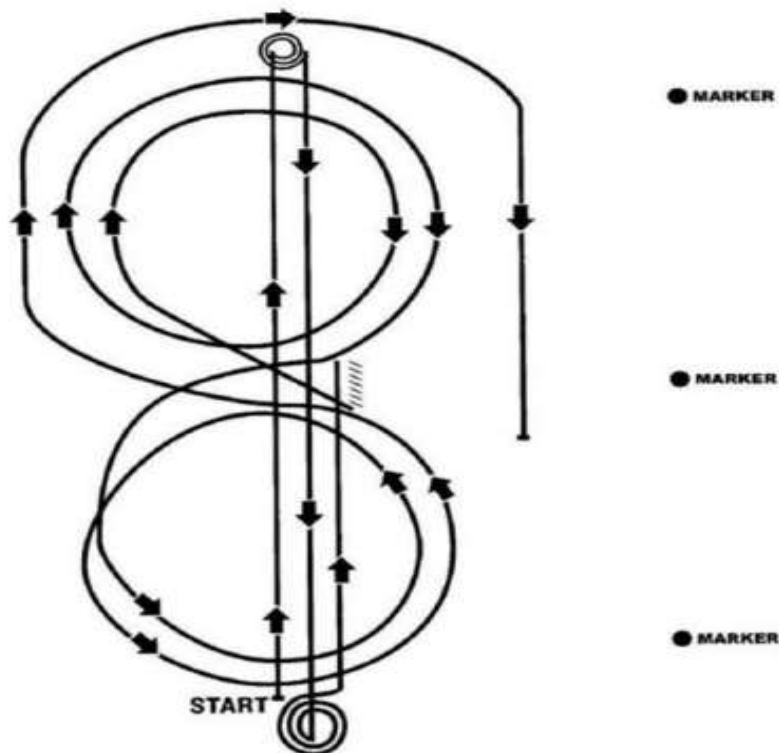

Mandatory Marker along Fence or Wall The judge shall indicate with markers on arena fence or wall the center of pattern. Judge shall also end place markers on fence or wall at least 50' from each end of the arena.

Ride pattern as follows:

1. Run up center of arena past the end marker and do a sliding stop.
2. Complete 3 1/2 spins to the left.
3. Run down to opposite end of arena, past the end marker and do a sliding stop.
4. Complete 3 1/2 spins to the right.
5. Run past the center marker and do a sliding stop. Back at least 10 feet. Complete 1/4 turn to the left; hesitate.
6. Beginning on right lead, complete two circles to the right - the first one small and slow, the second one large and fast. Change leads at center of arena.
7. Complete two circles to the left - the first one small and slow, the second one large and fast. Change leads at center of arena.
8. Begin a large circle to the right but do not close this circle. Run down the right side of the arena, past the center marker and do a sliding stop at least 20 feet from the fence. Hesitate to show completion of pattern.

VRH AND RHC RANCH REINING PATTERN 5

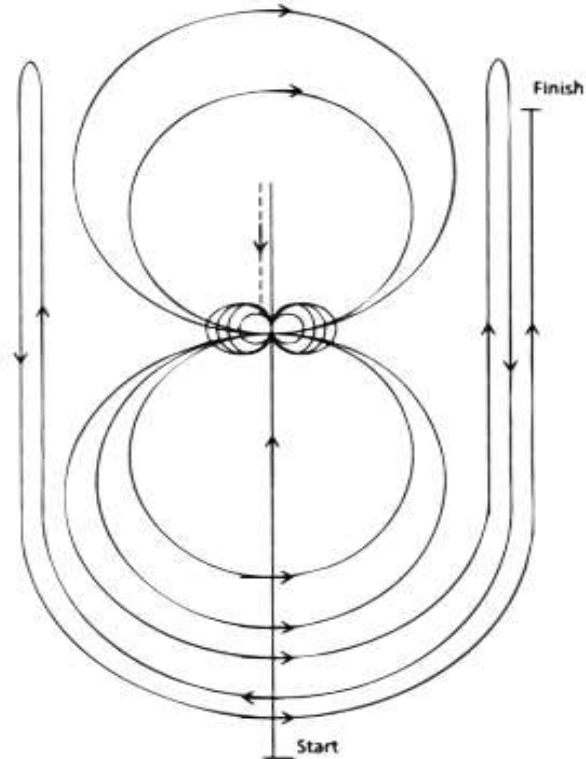

Mandatory Markers along Fence or Wall The judge shall indicate with markers on arena fence or wall the center of pattern. Judge shall also place markers on fence or wall at least 50' from each end of the arena.

Ride pattern as follows:

1. Run past the center marker and do a sliding stop. Back to center of arena or at least 10 feet. Hesitate.
2. Complete four right spins. Hesitate.
3. Complete four and one-quarter left spins. Hesitate. Horse to be facing left fence.
4. Beginning on left lead, complete two circles to the left - the first one small and slow, the second one large and fast. Change leads at center of arena.
5. Complete two circles to the right - the first one small and slow, the second one large and fast. Change leads at center of arena.
6. Begin a large circle to the left, but do not close this circle. Run up the right side of the arena, past the center marker, and do a right rollback at least 20 feet from the wall or fence.
7. Continue back around the previous circle, but do not close circle. Run up the left side of the arena, past the center marker, and do a left rollback at least 20 feet from the wall or fence.
8. Continue back around previous circle, but do not close this circle. Run up the right side of the arena, past the center marker, and do a sliding stop at least 20 feet from the wall or fence. Hesitate to show completion of pattern.

VRH AND RHC RANCH REINING PATTERN 6

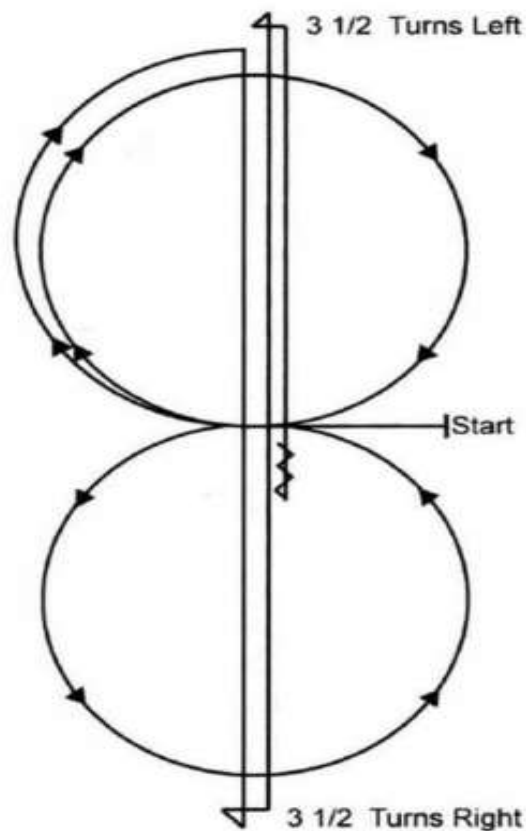

Mandatory Marker along Fence or Wall The judge shall indicate with markers on arena wall or fence the center of pattern. Judge shall also place markers on fence or wall at least 50' from each end of the arena.

Ride pattern as follows: Trot to center of arena and stop or walk before departure. Start pattern facing toward judge.

1. Beginning on right lead, lope one circle to the right. Change leads at center of arena.
 2. Complete one circle to the left. Change leads at center of arena.
 3. Begin a circle to the right, but do not close this circle. Run down center of arena, past the end marker, and do a sliding stop.
 4. Complete 3 1/2 spins to the right.
 5. Run up to other end of arena, past the end marker, do a sliding stop.
 6. Complete 3 1/2 spins to the left.
 7. Run past the center marker and do a sliding stop. Back at least 10 feet.
- Hesitate to show completion pattern.

VRH AND RHC RANCH REINING PATTERN 7

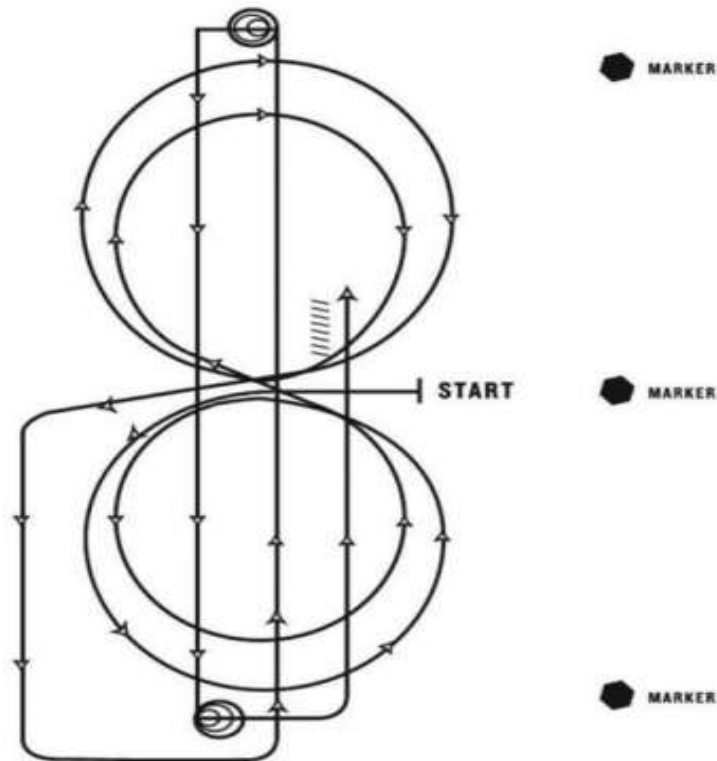

Mandatory Marker along Fence or Wall The judge shall indicate with markers on arena wall or fence the center of pattern. Judge shall also place markers on fence or wall at least 50' from each end of the arena.

Ride pattern as follows: Trot to center of arena and stop or walk before departure. Start pattern facing toward judge.

1. Beginning on left lead, complete two circles to the left - the first one large and fast, the second one small and slow. Change leads at center of arena.
2. Complete two circles to the right - the first one large and fast, the second one small and slow. Change leads at center of arena.
3. Begin a circle to the left, but do not close this circle. Continuing around the end of arena, run up the center, past end marker, and do a sliding stop.
4. Complete 3 1/2 spins to the left.
5. Run down to other end of arena, past the end marker, and do a sliding stop.
6. Complete 3 1/2 spins to the right.
7. Run past the center marker and do a sliding stop. Back at least 10 feet.

Hesitate to show completion pattern

RANCH RAIL PLEASURE

The ranch rail pleasure class measures the ability of the horse to be a pleasure to ride while being used as a means of conveyance from one ranch task to another and should reflect the versatility, attitude, and movement of a working horse. The horse should be well-broke, relaxed, quiet, soft, and cadenced at all gaits. The horse should be ridden on a relatively loose rein with light contact and without requiring undue restraint. The horse should be responsive to the rider and make timely transitions in a smooth and correct manner. The horse should be soft in the bridle and yield to contact. The ideal ranch rail horse should have a natural head carriage at each gait. In all gaits, movement of the ranch rail pleasure horse should simulate a horse needing to cover long distances, softly and quietly, like that of a working ranch horse. This class should show the horse's ability to work at a forward, working speed while under control by the rider. Light contact should be rewarded, and horse shall not be shown on a full drape of reins. The overall manners and responsiveness of the horse while performing the maneuver requirements and the horse's quality of movement are the primary considerations.

1. This class is intended as a rail class but individuals working off the rail will not be penalized, and in fact, riders are encouraged to use adequate space given the extension of gaits required.
2. The following terminology shall apply:
 - a. Walk – The walk is a natural, flat footed, four-beat gait. The gait is rhythmic and ground-covering. As in all gaits, the horse should display a level, or slightly above level topline with a bright, attentive expression.
 - b. Trot – The trot is a natural two-beat gait demonstrating more forward motion than the western jog.
 - c. Extended Trot – The extended trot is an obvious lengthening of the stride with a definite increase in pace. The horse should be moving in a manner as if it were covering a large area on a ranch with an above level topline.
 - d. Lope – The lope is a three-beat gait. The lope should be relaxed and smooth with a natural, forward moving stride.
 - e. Extended Lope – The extended lope is not a run or a race but should be an obvious lengthening of the stride, demonstrating a forward, working speed. The horse should display an above level topline with a bright, attentive expression.
 - f. Back: The horse should back straight at least one-horse length quietly and without gapping his mouth. This should be done smoothly with light contact and without hesitation.
 - g. Horses must be sound of limb.
3. Part of the evaluation of this class is on smoothness of transitions. A horse may be collected from the extended trot as the horse moves into the lope. The transition from the extended lope down to the trot is a transition to the seated trot, not the extended trot. Therefore, an extra cue to achieve this gait is expected. Horses that complete this total transition within three strides calmly and obediently should be rewarded. Horses that attempt to stop or do stop prior to trotting will be penalized. Judges expect to see horses that have been trained to respond to cues. To see these cues applied discretely and the horse responding correctly could be a credit earning situation.

4. To rein a horse is not only to guide him but also to control his every movement. The best reined horse should be willingly guided or controlled with little or no apparent resistance and dictated to completely. Any movement on his own must be considered a lack of control.
5. Posting or standing at the extended trot is acceptable.
6. Class shall work both ways of the ring at all requested gaits.

RANCH RAIL PENALTIES:

A contestant shall be penalized each time the following occur:

- a. Too slow/per gait.
- b. Over-bridled.
- c. Out of frame.
- d. Break of gait at walk or jog for 2 strides or less.
- e. Break of gait at walk or jog for more than 2 strides.
- f. Break of gait at lope.
- g. Wrong lead or out of lead.
- h. Draped reins.
- i. Out of lead or cross-cantering more than two strides.
- j. Trotting more than three strides when taking lead.
- k. Blatant disobedience (kick, bite, buck, rear, etc.).
- l. Major disobedience or schooling.
- m. Spurring in front of cinch.
- n. Use of either hand to instill fear/ praise.

RANCH COMFORMATION

The purpose of ranch conformation is to preserve ranch type horses by selecting well-mannered individuals in the order of their resemblance to the ideal and that are the most positive combination of balance, structural correctness, and movement with appropriate breed and sex characteristics, and adequate muscling. The ideal ranch conformation horse should have a natural ranch horse appearance from head to tail.

- 1 To be eligible to compete in the ranch conformation class, the horse must be shown in at least one riding class in the ranch division during that show.
- 2 All horses in each division will be shown together as one class: stallions, geldings, and mares, entering the ring and standing in that order.
- 3 All horses whose registration certificates are marked with a parrot mouth, cryptorchid or excessive white notation are ineligible to compete in the ranch horse conformation class.
- 4 All stallions shall be examined to confirm that they have two visible testicles.
- 5 All stallions and mares shall be examined for parrot mouth. If examination reveals that a horse has parrot mouth or is cryptorchid, such horse should be excused from the ring prior to final placing by the judge regardless of whether the parrot mouth or cryptorchid condition is marked on the horse's registration certificate.
- 6 Horses are to be shown in a good working halter: rope, braided, nylon, or plain leather. Any horse shown in the ranch horse conformation class may not be shown with an allowed lip cord or safety lead; however, a lead shank with an attached chain may be used under the chin or over the nose.
- 7 As the horse approaches, the judge will step to the right to enable the horse to trot straight to a cone placed 50 feet away. At the cone, the horse will continue trotting, turn to the left and trot toward the left wall or fence of the arena.
- 8 After trotting, horses will be lined up head to tail for individual inspection by the judge. The judge shall inspect each horse from both sides, front and rear, and place the horses in order of preference.
- 9 Exhibitors may qualify and show more than one horse in ranch conformation classes. Not allowing these horses to be shown by other exhibitors will make them ineligible for the all-around which will also affect the overall all-around results for other exhibitors; therefore, they may be shown by another exhibitor other than the original person showing the horse.
- 10 For additional rules concerning halter not addressed in ranch conformation see "Rules For Halter Classes."